

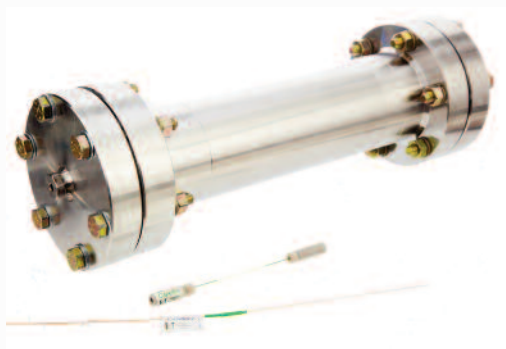

Higgins
Analytical

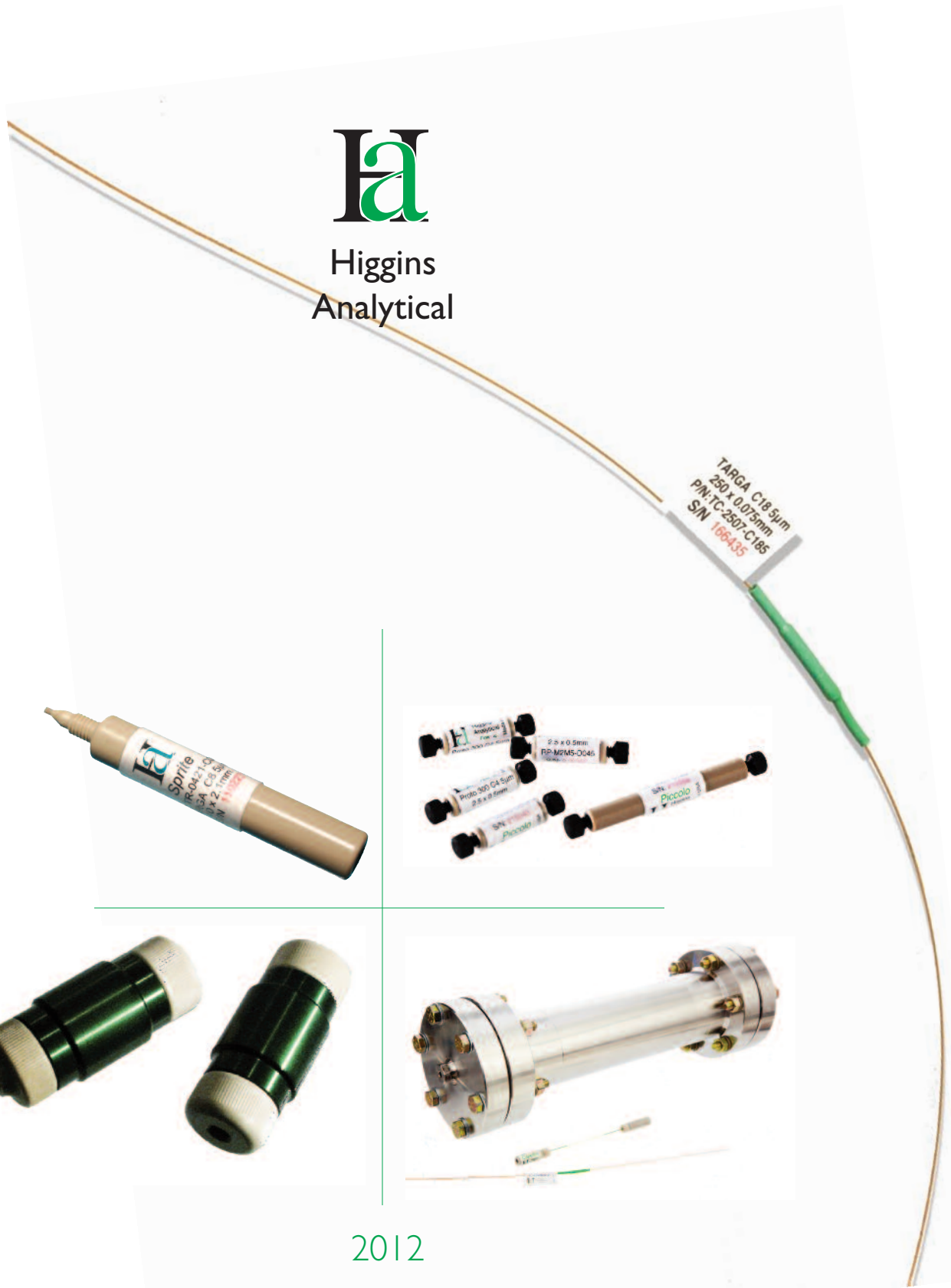

2012

Higgins Analytical is a quality oriented company, dedicated to providing high performance products, expert support, and rapid delivery to research and quality control laboratories worldwide.

Higgins Analytical on kromatografiakolonneja valmistava yritys, joka tarjoaa laadukkaita tuotteita, asiantuntevaa palvelua ja nopeat toimitukset tutkimus- ja laadunvalvontalaboratoriolle maailmanlaajuisesti.

हिगिन्स विश्लेषणशाखा एक गुणप्रधान कम्पनी है जो समस्त विश्व की शोधन एवं गुण-निश्चयन प्रयोगशालाओं को क्रियात्मक उत्पादन, विशेषज्ञ-सहायता तथा द्रुत निगमन को विश्वस्त सेवकें प्रदान करती है.

היג'ינס אנליטיקל הינה חברה שדוגלת באיכות, מחויבת למוצרים בעלי ביצועים גבוהים, תמיכה מעולה ואספקה מהירה למעבדות מחקר ובקרת איכות, בעולם כולו.

La Higgins Analytical é una società orientata verso l'alta qualità, dedicata a fornire ai laboratori di ricerca e controllo qualità nel mondo prodotti ad alto livello, supporto di esperti e rapide consegne.

希度分析儀器公司是一個高品質走向的公司，致力於生產高效能產品、提供專業技術服務、並且交貨迅速、以供應全球的品管和研究機構。

Higgins Analytical est une société ayant pour objectif la qualité et de proposer des produits performants, un support expert, des livraisons rapides pour les laboratoires de recherches et de contrôle qualité à travers le monde.

Higgins Analytical 은 세계각국의 품질관리 연구소에 고품질 제품의 제공과 전문가 지원 그리고 빠른 전송에 공헌해온 품질지향적 회사입니다.

I Higgins Analytical iyinkampani engusaziwayo kwezobuchwepheshe. Izinikele ekuthini ikhiqize umkhiqizo oseqophelweni eliphezulu. Izebenzisa uxhaso oluphambili ukukhipha imiphumela ecutshungwe kahle nangokushesha kanye nezindawo zokucubungula eziseqophelweni eliphezulu emhlabeni jikelele.

Higgins Analytical es una compañía dedicada a proveer productos de óptima calidad, excelente rendimiento, experto soporte técnico y entrega inmediata a los laboratorios de investigación y de control de calidad del mundo entero.

هيجينس اناليتيكال مفرقة تعنيها الجودة في المقام الأول وهدفها تقديم منتجات التحليل الكروماتوجرافي عال الأداء وضمان توفير الدعم الفني و سرعة تقديم الخدمة الى معامل الأبحاث ورقابة الجودة في أنحاء العالم.

Higgins Analytical ist eine Qualitäts orientierte Firma, welche sich der Lieferung von leistungsfähigen Produkten widmet, Kundenunterstützung durch Experten, sowie rasche Lieferung an Forschungs und Qualitätskontrollenrichtungen ist weltweit unser Ziel.

Higgins Analytical er fyrirtæki sem leggur áherslu á gæði, býður hágæða vöru og sérfræðipjónustu með stuttum afgreiðslufresti, fyrir fyrirtæki á sviði rannsókna og matvælaefirlits.

Higgins Analytical ایک معیاری کمپنی ہے جو کہ اعلیٰ مصنوعات، ماہرانہ صدر اور تیز ڈیلیوری بین الاقوامی کوالٹی کنٹرول اور تحقیق لیباریٹری کو فراہم کرتی ہے۔

Higgins Analytical は質の高い仕事をめざす会社です。

お客様の満足を求めて、高品質製品の提供、専門家によるサポート、

また各国の研究室や品質管理ラボへの迅速なデリバリーに専心しています。

Higgins Analytical, hedefi yüksek performanslı ürünler sağlamak olan, dünya genelinde araştırma ve kalite kontrol laboratuvarlarına expert destek veren ve hızlı dağıtım yapan kalite odaklı bir şirkettir.

Higgins Analities is 'n kwaliteits-georiënteerde maatskappy wat toegewyd is om produkte van hoogstaande gehalte, kundige ondersteuning en snelle lewering van produkte vir navorsings-en gehalte-beheer laboratoria wereldwyd te voorsien.

Представленная во всем мире компания Джереми Хиггинса, посвящает свою работу представлению высококачественной продукции, консультацию и поддержку опытными специалистами, и быстрой доставке всех требуемых материалов для исследовательских лабораторий и лабораторий занимающихся вопросами качественного контроля.

Công ty Higgins Analytical chú trọng đến chất lượng, chuyên cung ứng các sản phẩm đem lại hiệu quả cao. Là chuyên gia trong ngành hóa phân tích, công ty luôn bảo đảm việc cố vấn, bảo hành sản phẩm chu đáo và giao hàng nhanh chóng đến các phòng thí nghiệm kiểm định chất lượng cùng các phòng thí nghiệm nghiên cứu ở mọi nơi trên toàn thế giới.

CONTENTS



HIGGINS ANALYTICAL 2 - 3



CLIQUEUS™ 4 - 5



HAISIL 100™ 6 - 7



HAISIL 300™ 8 - 9



HAISIL HL™ 10 - 11



HEAVY™ **NEW** 12



Some Interesting Facts 13

200

PROTO™ 200 **NEW** 14 - 15



PROTO™ 300 **NEW** 16 - 17



PHALANX™ 18 - 19



TARGA® 20 - 21

PLRP-S
PL-SAX
PL-SCX
PL-WAX

POLYMERIC 22

Part Number Guide 23
XX-**nn**XX-XXX XX-XX**nn**-XXXX XX-XXXX-**nnn**X



HPLC COLUMNS 24 - 29



MICROBORE COLUMNS 30 - 37



SEMI-PREP Columns and PREP Columns 38 - 41



Capillary™ NEW 42 - 43
75µm and 150µm Columns



Capellini™ 44 - 49



SPRITE™ 46 - 47



PICCOLO™ 50 - 52
NEW 30x1.0mm for more capacity



s.s. Analytical Cartridges 56 - 59



PEEK/Titanium Cartridges 60 - 63



10mm Cartridge Columns 64 - 65



Analytical Guard Cartridges 66 - 69



Prep Guard Cartridges 70 - 71
NEW 35x20 & 50x20mm sizes



Cartridge Holders 72- 73



Parts and Accessories 74

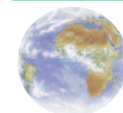

Ordering, Warranty, Trademarks 76 - 77

Experience, Expertise, Continuity

Higgins Analytical was founded in early 1994, but that is only half of the story. The two founders had already been packing commercial HPLC columns for more than fifteen years before that. Besides a lot of expertise, our experience brings an unrivaled continuity to the field.

Total Quality Approach to all Aspects of Design, Manufacturing and Testing

Each HPLC column and analytical cartridge from Higgins Analytical is evaluated by a computerized performance test prior to receiving a quality

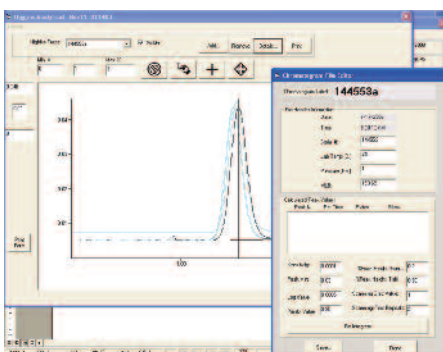

control approval. This testing protocol involves a highly accurate statistical moments determination of the column's performance characteristics. These sensitive peak shape and column efficiency measurements can only be made by computerized data logging methods. The raw digital chromatogram for every column we have manufactured since March 1994 is retrievable from our archives.

Product Traceability

The test data for these serialized columns include sorbent properties and lot number as well as complete description of the test conditions. We are able to trace the serial number of every



column to the customer that originally purchased the column.

Comprehensive Record Keeping and Statistical Quality Control

Raw digital test data is automatically archived for every column and analytical cartridge we manufacture. As a result, it is a simple matter for us to retrieve comprehensive quality control information and routinely apply it to our statistical process control activities. This

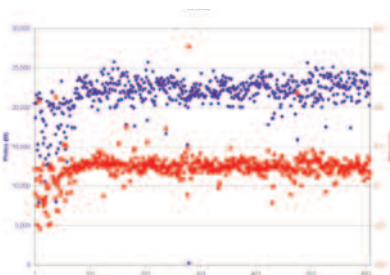

commitment to quality manufacturing and comprehensive record keeping permits us to produce replacement Certificates of Analysis when requested by laboratories complying with their internal GLP needs. And, most

importantly, we are able to assist customers during the lengthy process beginning with method development and optimization to validation and NDA filing by providing comprehensive serial number, manufacturing date, sorbent lot, and performance data for every column they ever purchased.

Expert Manufacturing and State-of-the-Art Equipment

Two of Higgins Analytical's staff have been involved with the chemical separations business for over 30 years, others for only 10 or 15. By focusing this expertise exclusively on the separations consumables business, high quality products as well as high quality processes are assured. A key element of this expertise is the electronic manufacturing

lab book that we have developed. All of our column packing equipment is controlled by this electronic book, and all methods are electronically stored. It is impossible to pack a column without the electronic lab book being completely documented. Processes cannot be

changed without an expert supervisor's intervention. When new processes for new products are developed or optimization is required for an existing method, a complete audit trail is created for every condition change that is made. The packing pumps operate with PID (proportional integral/derivative) controllers allowing for control flow rate,



rather than pressure, throughout the packing process. This is a very important point. Common folklore is that it takes high pressure to pack an HPLC column. Actually, pressure is only the result of a



complex two phase (liquid/solid) flow. This flow, not pressure, is what produces a packed bed. The "pressures" used by many column manufacturers are the result of flow rates that approach the velocities that will produce a "fluidized bed" during certain phases of the packing process, not exactly a condition that will produce a stable, optimally packed column. In addition to being able to control our equipment digitally, we are able to data log the actual conditions as well.

Our unique and highly automated column packing process is based on a closed, continuous flow system employing recoverable, unreactive, and safe fluids. And the best part about it is that it enables Higgins Analytical to manufacture a wide variety of HPLC columns with unrivaled efficiency.

Quality and Environmental Aspects of Process Solvents

Proper composition of slurry and packing solvents is vital to the whole process. Our solvent purification equipment and procedures allow us to address all of the solvent requirements for production and quality control. Not only does this investment permit us to use the highest purity solvents available, it also eliminates much of the expensive and environment-polluting solvent disposal practice characteristically found in today's chemical industry.

Unique Bonded Phase Synthesis

Chemists at Higgins Analytical have been producing bonded phases since 1979. During this long experience, we have pioneered many technologies long before they were "discovered" by others with a bigger marketing clout. Higgins Analytical's introduction of a "No



Requirement for TFA" HPLC column in early 1997 is just one example of our vanguard approach to this field.

Computer Aided Drawings and Numerical Control Machinery

Key to reinforcing our ability to provide the highest performance-to-price ratio products available in the separations consumables industry has been our investment in computer aided design (CAD) technology and computer numerically controlled (CNC) machinery. SolidWorks™ software is used by our engineers which permits us to design HPLC hardware and see it in its

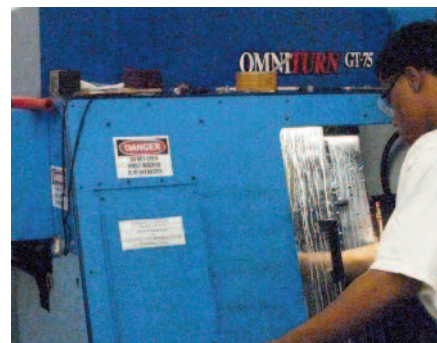
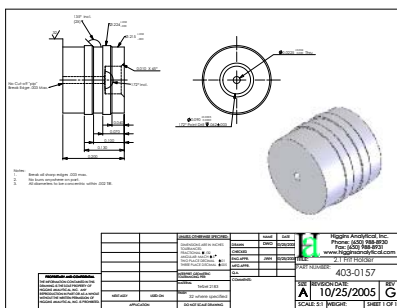

assembled 3D form before we manufacture it. Dedicated tooling and secure backups of machine code assure fast setups and consistent high quality production of all the stainless steel and plastic components in each product line.

Our product development, manufacturing, and testing processes strictly follow a systematic and well documented cycle.

A Certificate of Analysis, like the one below for a 3cm x 10mm cartridge, accompanies each HPLC Column and Cartridge we manufacture

Note: This high performance cartridge is typically used as a guard column.

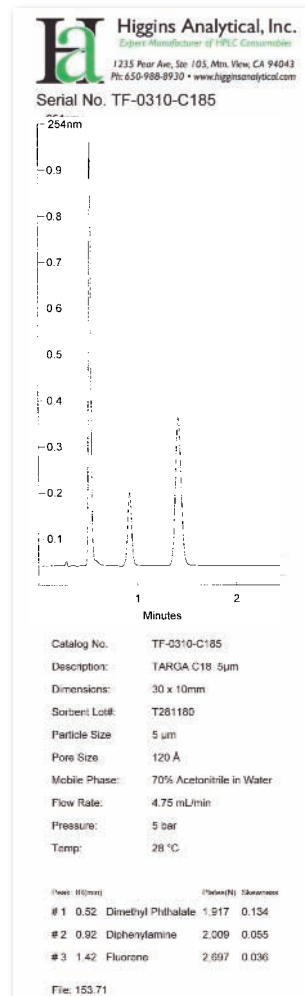

CLIQUEUS A "Small Shield" for a Big Job



Phases	Silica, C8, C18, Cyano, Phenyl
Particle Sizes	4.5 and 10µm
Pore Size	120Å
Pore Volume	0.8mL/gm
Surface Area	330m ² /gm
Carbon%(w/w)	C18 = 18%
Phase type	Extremely well end-capped monofunctional phases
Silica Class	Type B

Applications

The high purity base silica and thoroughly end capped bonded phases insure that CLIQUEUS columns and cartridges will perform well in demanding situations where many other column brands fail. Even polar compounds elute as sharp and symmetrical peaks permitting surprisingly short columns to be used for high speed analysis. In addition to Silica, C8 and C18 phases, CLIQUEUS columns are available with phenyl or cyano functionality.

Guide to CLIQUEUS Part Numbers

Cx-xxxx-SIL5	CLIQUEUS Silica 5µm
Cx-xxxx-C085	CLIQUEUS C8 5µm
Cx-xxxx-C185	CLIQUEUS C18 5µm
Cx-xxxx-CNP5	CLIQUEUS Cyano 5µm
Cx-xxxx-PHN5	CLIQUEUS Phenyl 5µm

See Page 23 for complete Part Number information

This unbuffered Pyridine and Phenol chromatogram illustrates the absence of any undesirable solute/silanol interaction on a CLIQUEUS C18 HPLC Column.

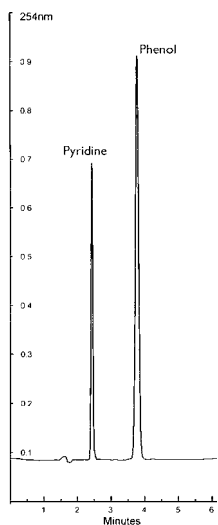

CLIQUEUS C18 5µm 150x4.6mm

40% MeOH/water (unbuffered)
1mL/min, 25°C, 254nm
P/N CS-1546-C185

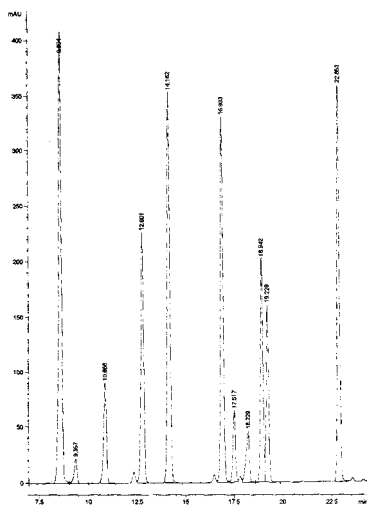

Carbamates and Urea Pesticides
EPA 632A

Industrial and Municipal Waste Water
Column P/N CS-2546-C185

- | | |
|-----------------|----------------|
| 1. Monuron | 2. Propoxur |
| 3. Carbaryl | 4. Propham |
| 5. Diuron | 6. Linuron |
| 7. Methiocarb | 8. Mexacarbate |
| 9. Chlorpropham | 11. Neburon |
| 10. Barban | |

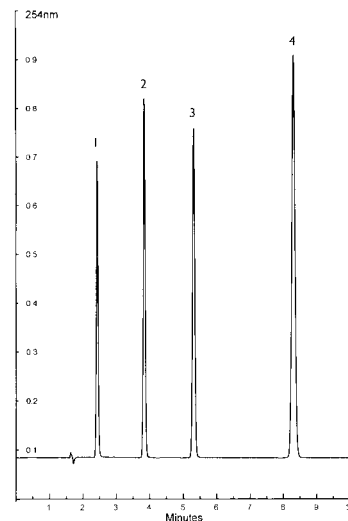

Methylxanthines

CLIQUEUS C18 150x4.6mm
P/N CS-1546-C185
25% MeOH/water (unbuffered)
1mL/min, 30°C, 254nm

- | | |
|----------------|-----------------|
| 1. Theobromine | 2. Theophylline |
| 3. Caffeine | 4. Phenol |

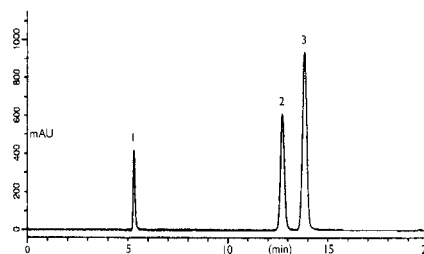

Sunscreen Formulation

CLIQUEUS C18 250x4.6mm
P/N CS-2546-C185
87.5% MeOH/ 12.5% water (unbuffered)
1mL/min, 30°C, 285nm

- | | |
|---------------------------|---------------|
| 1. Oxybenzone | 2. Padimate O |
| 3. Octyl Methoxycinnamate | |



Comparative Selectivity of CLIQUEUS HPLC Columns

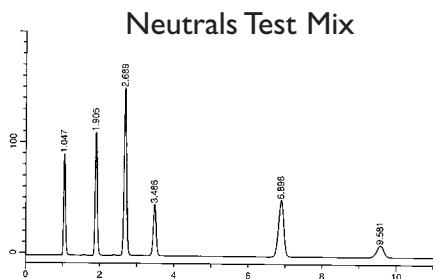

CLIQUEUS C18 150x4.6mm P/N CS-1546-C185

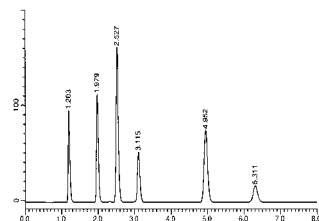
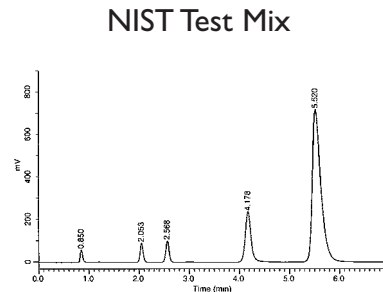

CLIQUEUS C8 150x4.6mm P/N CS-1546-C085

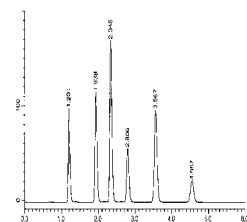
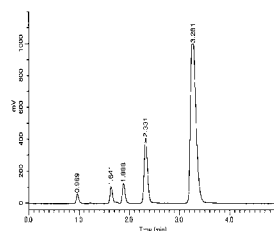

CLIQUEUS Phenyl 150x4.6mm P/N CS-1546-PHN5

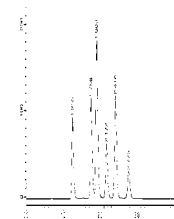
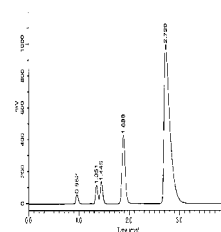

CLIQUEUS Cyano 150x4.6mm P/N CS-1546-CNP5

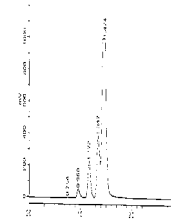

50% MeCN/water, 1.5mL/min, 205nm

1. Thiourea
2. Phenol
3. Acetophenone
4. Nitrobenzene
5. Toluene
6. Napthalene

80% MeOH/Buffer, 1.5mL/min, 254nm
Buffer: 20mM potassium phosphate

1. Uracil
2. Toluene
3. Ethylbenzene
4. Quinizarin
5. Amitriptyline





HAISIL 100 The Workhorse

Phases	Silica, C8, and C18
Particle Sizes	3µm and 5µm
Pore Size	100Å
Pore Volume	0.5mL/gm
Surface Area	190m ² /gm
Carbon%(w/w)	C8 = 7%(w/w), C18 = 12%(w/w)
Phase type	Monofunctional & fully endcapped
Silica Class	Type A

Guide to HAISIL 100 Part Numbers

Hx-xxxx-SIL3	HAISIL 100 Silica 3µm
Hx-xxxx-M183	HAISIL 100 C18 3µm
Hx-xxxx-SIL5	HAISIL 100 Silica 5µm
Hx-xxxx-M085	HAISIL 100 C8 5µm
Hx-xxxx-M185	HAISIL 100 C18 5µm

See Page 23 for complete Part Number information

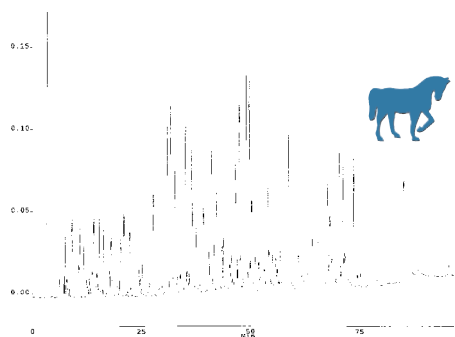

Tryptic Map of Transferrin on HAISIL 100
250x4.6mm P/N HS-2546-M185

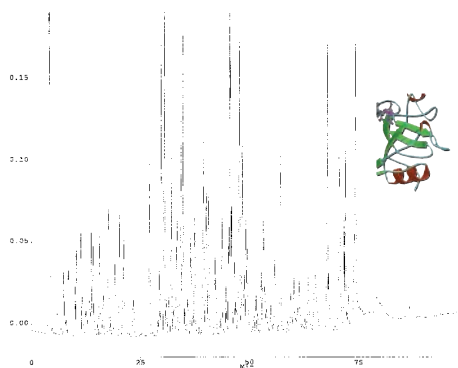

Tryptic Map of Transferrin on HAISIL 300
250x2.1mm P/N HS-2521-W185

Applications

HAISIL 100 columns and cartridges are very good general purpose columns that are particularly well suited for small molecules and peptide applications. The HAISIL 100 column and cartridge efficiencies are unrivaled yet they represent one of the most economical product lines in the market today. In formats ranging from 0.075 to 20mm ID and from 10 to 250mm in length,

100Å vs. 300Å Columns for Peptide Mapping

The question of whether to use a 100Å or 300Å column for mapping usually divides peptide chromatographers into two groups. Rather than take sides, we have chosen to offer very efficient columns with both pore diameters to suit both camp's preferences. HAISIL 100 and HAISIL 300 columns are available in 10 to 250mm lengths and 0.075mm to 20mm internal diameters.



Hormone Analogs

LH-RH (Luteinizing Hormone - Releasing Hormone) Analogs are used for the inhibition of gonadal steroid production. An important application area is in the treatment of prostate cancer.

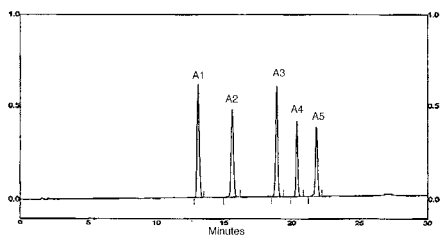

Conditions
 HAISIL 100 C18 5µm 150x4.6mm
 Solvent A: Phosphoric acid, ammonium sulfate aqueous buffer
 Solvent B: Acetonitrile.
 Linear gradient at 1mL/min
 254nm detection

Analogs:

- A1: pGlu-His-Trp-Ser-Tyr-(d-Ser(but))-Leu-Arg-Pro-NHEt
- A2: pGlu-His-Trp-Ser-Tyr-d-Ala-Leu-Arg-Pro-NHEt
- A3: pGlu-His-Trp-Ser-Tyr-d-Leu-Leu-Arg-Pro-NHEt
- A4: pGlu-His-Trp-Ser-Tyr-d-Ala-Trp-Leu-Pro-NHEt
- A5: pGlu-His-Trp-Ser-Tyr-d-Trp-Leu-Arg-Pro-NHEt

Alkaloids

A Peruvian vine named "Una de Gato" (*Uncaria tomentosa*) and commonly referred to as Cat's Claw, has become a popular natural product source for herbal remedies. Enthusiasts claim the oxindole alkaloid extracts to be effective in the treatment of a wide range of digestive and circulatory diseases as well as other afflictions ranging from cancer to arthritis. Reputable providers of such phytochemical containing formulations carefully assay the alkaloid content of the extracts and formulations. The chromatogram above illustrates baseline resolution of Cat's Claw bark extracts containing isopteropodine, pteropodine, mitraphylline, isomitraphylline, ryncophylline and isorynchophylline.

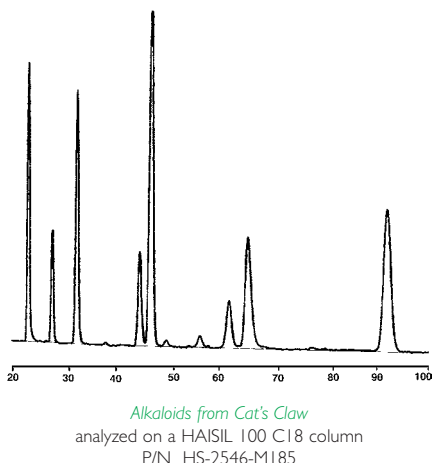

Kinetic Measurements in Disease Research

Researchers at the University of California, Santa Cruz have recently published a novel HPLC method that yields baseline separation of per-deuterated and protonated lipoxygenases.

The striking ability of a 250x4.6mm HAISIL 100 C18 column to resolve these two very similar compounds is enabling researchers to study large competitive kinetic isotope effects in Human 15-lipoxygenase catalysis. Protio/per-deutero ratio data obtained by this HPLC method agreed within experimental error of data obtained by ES-MS.

The elucidation of these mechanisms is noteworthy because of the increasing role human lipoxygenases are playing in inflammatory diseases and cancer growth regulation.

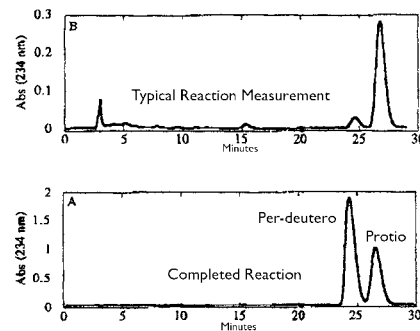

Enzymatic Reaction Mixtures of Human 15-lipoxygenase

HAISIL 100 C18 250x4.6mm
 74.9% MeOH, 25% water, 0.1%HoAc
 1mL/min, 234nm
 P/N HS-2546-M185

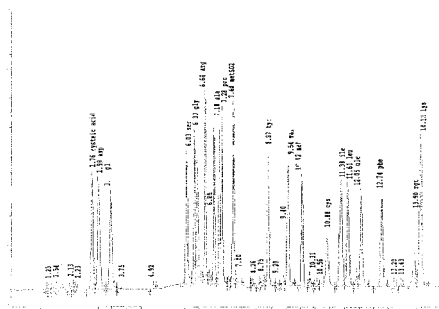

Economical Alternative for PICOTAG Analysis

Our HAISIL 100 C18 columns have demonstrated superior resolution and life time for PICOTAG™ amino acid analysis when compared to considerably more expensive columns from other manufacturers. Besides good linearity and column lifetime, the 150x4.6mm column yields very efficient amino acid analysis as shown in the chromatogram above (P/N HS-1546-M185).

HAISIL 100 - the Separations Work Horse

The 100Å pore size, monomeric bonded phase, and very high performance make HAISIL 100 an ideal choice for separations ranging from small molecules such as carbamate pesticides and pharmaceu-

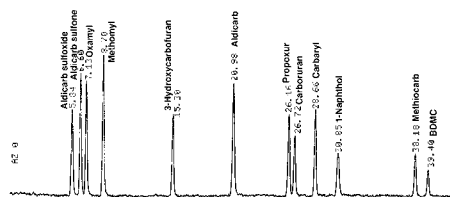

Carbamate Pesticide Analysis
 250 x 4.6mm HAISIL 100 C18

tical drugs to synthetic oligonucleotides and small peptides. High efficiency, symmetrical peaks, and long column life is characteristic not only of the C8 and C18 reverse phase columns, but the normal phase silica columns as well.



HAISIL 300 For Biomolecules

Phases	C18
Particle Sizes	5 and 10µm*
Pore Size	300Å
Pore Volume	0.7mL/gm
Surface Area	80m ² /gm
%Carbon (w/w)	C18 = 6%
Phase type	Monofunctional and fully endcapped
Silica Class	Type A

Guide to HAISIL 300 Part Numbers

Hx-xxxx-W185 HAISIL 300 C18 5µm

See Page 23 for complete Part Number information

* 10µm is offered in HAISSpeed 20 Guard Cartridges only. See pages 68-69.

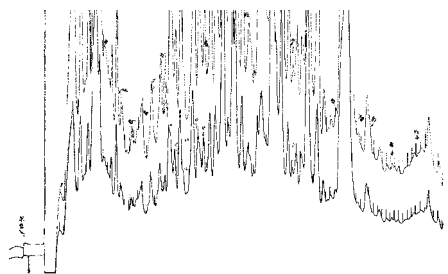

Fractionation of a Purified Tumor Cell Extract

Peptides ranging from 100 fmol to 1 pmol are collected in 40sec intervals during a 70min gradient from 0 - 60% MeCN with HFBA modifier. A 40x2.1mm HAISIL 300 C18 5µm cartridge column (HK-0421-W185) is used.

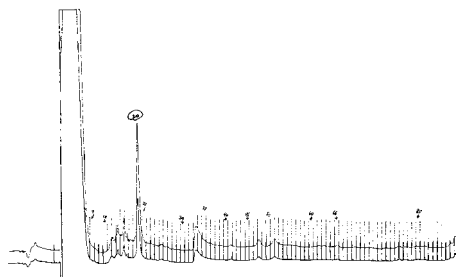

*Reanalysis of a Fraction
from the Chromatogram above*

The same 40x2.1mm HAISIL 300 cartridge is used for a 70min gradient from 0-60% MeCN with TFA modifier. Tic marks indicate 40sec fraction collections.

**Applications**

HAISIL 300 columns and cartridges are ideal for biomolecule separations such as peptides and small proteins. Optimized phase bonding and column packing techniques assure unsurpassed performance and column-to-column reproducibility. Short cartridge columns are economical and are ideally suited for LC/MS applications. The column and cartridge offering ranges from 150µm to 20mm I.D. which means that bioseparations can be optimized by selecting a format that best fits your analytical requirements.

Micro-Preparative HPLC

Higgins Analytical Cartridge Columns are helping researchers understand the immune response of living cells. An investigation to understand the genetic control of the immune response systems in organisms involves the extraction, isolation, and identification of more than 10,000 peptides. These distinct peptides are bound to a major histocompatibility complex (MHC) molecule on tumor cells.

Extraction of approximately 5×10^{10} cells yield several nanomoles of a very complex peptide mixture. Several rounds of RP-HPLC with different organic modifiers on a 40x2.1mm PEEK cartridge column (HAISIL 300 C18 5µm, P/N: HK-0421-W185) are performed to fractionate the mixture into individual components.

The chromatograms on the left illustrate how this technique is being used to narrow the search for the one peptide that marks a particular tumor cell as being diseased enabling it to be recognized by the immune cells.



Peek and Titanium cartridge columns used in the application described above. P/N: HK-0421-W185

Very High Peak Capacity

Depending upon the type of information a protein chemist is seeking, the HPLC analysis of a complex digest can take 1 to 2 hours. The following chromatogram

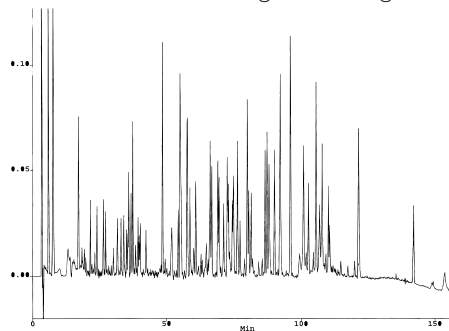

Tryptic Map of BSA
on HAISIL 300 C18 5µm 250x4.6mm
P/N HS-2546-W185

illustrates a high resolution tryptic digest map of BSA on a 250x2.1mm HAISIL 300 C18 5µm column indicates peak capacities in excess of 100. Small proteins, on the other hand can yield fewer fragments, and if only a "fingerprint" of a digest is required, high peak capacity columns can be a waste of time.

Fast Analysis of a Complex Drug Delivery System

Most pharmaceutical QC laboratories are faced with rapidly increasing demands for high throughput capability. A good example of one laboratory's

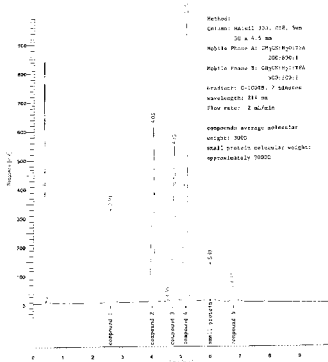

approach to addressing a large number of samples for analysis on a daily basis is summarized below. This novel drug delivery system contains a small protein and other components that span an order of magnitude in molecular weight. All the compounds of interest were easily resolved in a single analysis with a fast linear gradient on a 5cm long HAISIL 300 C18 5µm column.

Peptide Map in 5 minutes

The figure below illustrates a very fast

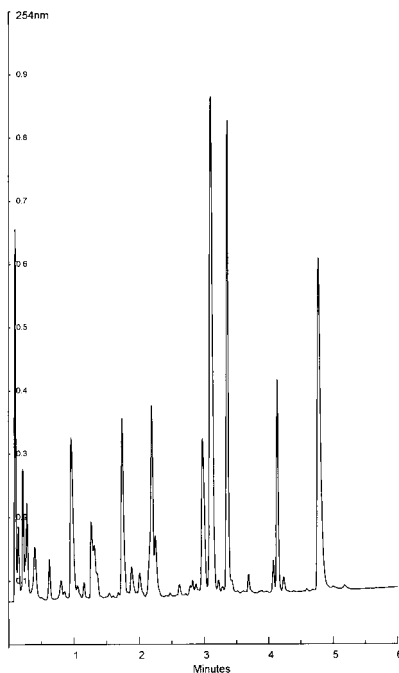

peptide map of cytochrome-C. The information that can be gleaned from this five minute profile is more than adequate for many analytical requirements. The robust 50x4.6mm HAISIL 300 C18 column provides hundreds of runs without performance loss even under the aggressive 6ml/min flow conditions used in this example.

The cytochrome-C is a good example of pushing a column beyond its optimum operating conditions (more than six times optimum linear velocity) and still being able to get desired results. The same column can be run under more conventional conditions with a flatter gradient to obtain even higher resolution separations. The rhGH tryptic map below was done on a 5cm long column that replaced the conventional 25cm column that was used initially.

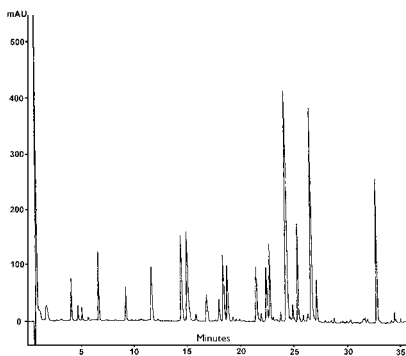

Fast Tryptic Map of rhGH
50x4.6mm HAISIL 300 C18

The Role of Column Length in Gradient Separations

Changes in column length have a direct and linear effect on theoretical plates and analysis time in isocratic separations. Column length plays a less important role, however, in gradient techniques. The three chromatograms below illustrate how well packed short HPLC columns yield very similar peptide separations under identical gradient conditions.

For this study, the 2.1mm I.D. HAISIL 300 C18 5µm columns ranged from 250 to 100mm in length. While solvent and analysis time savings may be minimal, column cost savings can be significant when using as short a column as possible. Short columns also exhibit lower pressure at high flow rates.

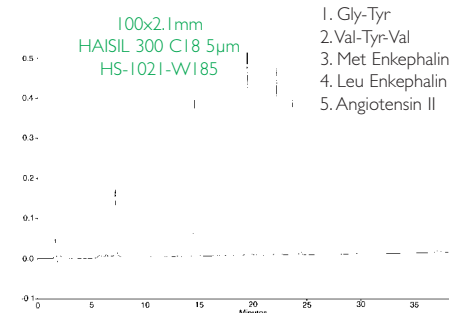
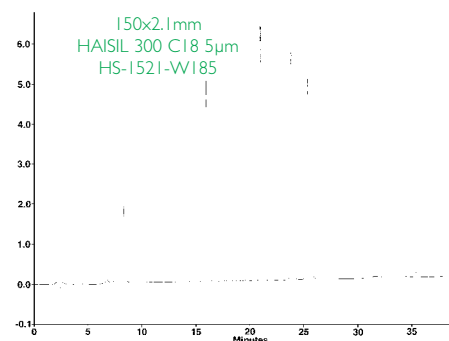
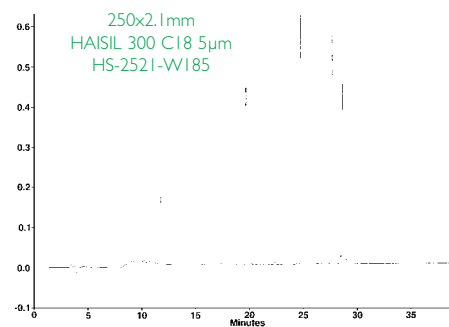

1. Gly-Tyr
2. Val-Tyr-Val
3. Met Enkephalin
4. Leu Enkephalin
5. Angiotensin II

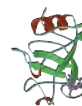

HAISIL HL High Load

Phases	C18
Particle Sizes	5µm
Pore Size	100Å
Pore Volume	0.8mL/gm
Surface Area	300m ² /gm
%Carbon (w/w)	C18 = 18%
Phase type	Monofunctional & fully endcapped
Silica Class	Type B

Guide to HAISIL HL Part Numbers

Lx-xxxx-C185 HAISIL HL C18 5µm
See Page 23 for complete Part Number information

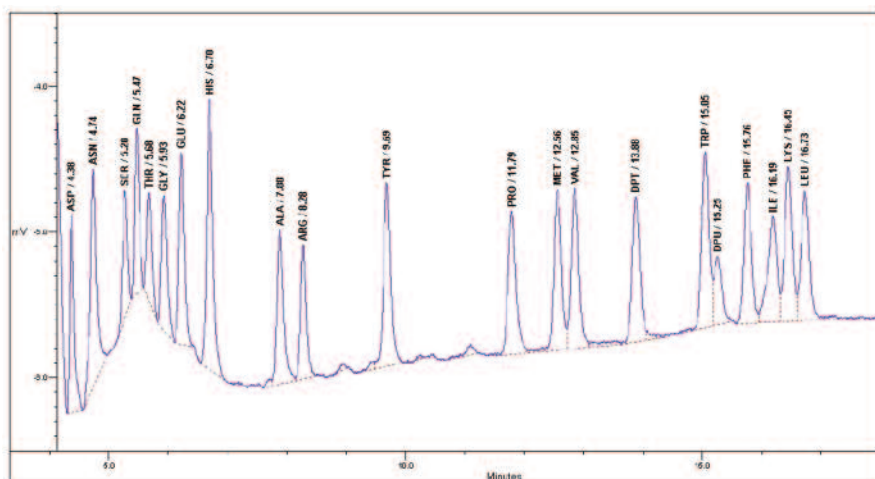
A new "fast" cycle for high sensitivity Edman Sequencing**Abstract**

Previously, we presented a complete 20-minute "fast" Edman chemistry cycle for the Applied Biosystems Protein Sequencer, HT series (49X-HT). Here we describe a new "fast" cycle for the high sensitivity cLC series (49X-cLC) instrument. The 35-min cycle includes a 20-min reversed phase capillary HPLC separation of the phenylthiohydantoin (PTH)-amino acids. The normal cycle time of the 49x-cLC was approx. 50 minutes; therefore approximately 10 hours were required to complete 10 residues of sequencing. With the new cycle, 10 residues of sequencing can be

completed in only 7.5 hours. Using this rapid cycle on the 492 or 4-cLC protein sequencer, 10 residues of sequencing on 2 different proteins can be automatically completed within a night.

In developing this rapid cycle, we have created new cartridge and flask cycles and sequencing methods. We are using a shorter C18 RP-HPLC capillary column for the chromatography and have developed a new gradient. We will describe all the changes made to the standard system. We will also present protein and peptide sequencing results that were generated using this rapid cycle.

Poster 4P-52378th Annual Meeting of the Japanese Biochemical Society - Oct 2005
Y. Shionoya, D. Dupont, H. Hiranuma, S. Ando

Applications

HAISIL HL "high load" columns and cartridges are intended for applications requiring maximum loading and selectivity. The high surface area permits high bonded phase loading yet the monofunctional bonded phase and the absence of micro-pores eliminates the problems that plague many of the so-called "high capacity" columns currently on the market. The Type B silica backbone is pure, robust, and stable under harsh conditions. Users report satisfactory lifetime when used for prolonged periods at pH as high as 9.

High Speed Analysis of Paraben Food Preservatives

Parabens represent another example of food additives that are routinely analyzed by HPLC. Often, the food matrix being assayed for preservative content requires exhaustive cleanup and pre-filtration in order to prevent clogging of columns with nonporous or 2µm sorbents recently suggested for this analysis. As in the previous diet cola example, the compounds of interest are base line resolved under isocratic conditions. The inexpensive HAISIL HL 5µm 20x2.1mm cartridge column and the 50 second analysis time contribute significantly towards reducing operating costs.

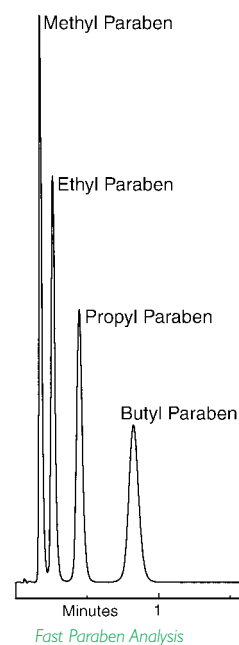

HAISIL HL C18 5µm
20x2.1mm Cartridge
LK-0221-C185
700µL/min, 40% MeCN/water



HPLC Peptide Standards for RP on the HAISIL HL C18 Column

The aromatic hydrocarbons that most HPLC column manufacturers use to quality control columns render little information about a column's selectivity

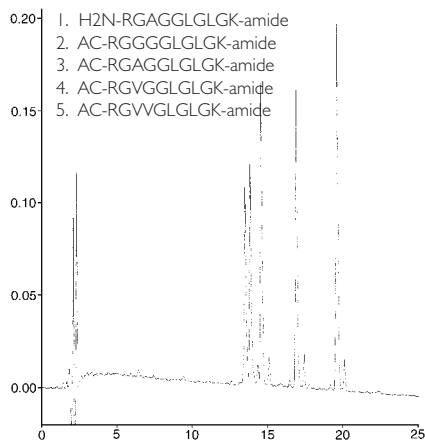

"Hodges Test Peptide Mix"
(from Synthetic Peptides, Inc.)

HAISIL HL C18 5µm
150x4.6mm P/N LS-1546-C185

and performance characteristics for peptides. The Canadian corporation, SPI, produces a well characterized yet challenging peptide mixture that is very useful for quantifying HPLC column performance for peptides. The difficult to separate first pair of peptides are resolved to near base line on HAISIL HL C18 columns. Many so-called peptide analysis columns are unable to separate this pair.

Water Soluble Vitamin Analysis on HAISIL HL

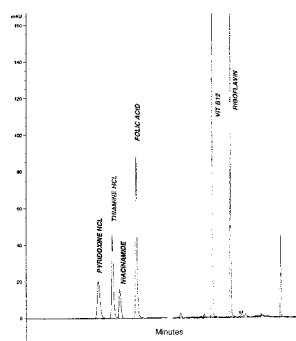

Water Soluble Vitamins

HAISIL HL C18 5µm 250x4.6mm
A: 0.05mM KOAc, pH5; B: MeCN
Gradient: 2.5% - 30%B in 25min

Food Additives

Beverage additive analysis is not only an important industrial application, but it also serves as a practical and relatively simple procedure for introductory HPLC courses. Industry is increasingly driven by rapid analysis requirements and an HPLC column can represent an overwhelming expense in a teaching environment. The diet cola analysis in the chromatogram to the left illustrates an extremely fast analysis on an extremely inexpensive HPLC column. A package containing five

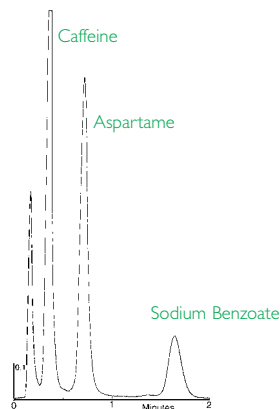

Fast Diet Cola Analysis

HAISIL HL C18 5µm
2cm x 2.1mm Cartridge PN LK-0221-C185
15% MeCN/Water 200µL/min

of the 20x2.1mm cartridge column used for this analysis costs about half as much as one moderately priced HPLC column. And, there's no need to pre-filter the cola sample through a 0.5µm filter as some column manufacturers recommend when using their expensive columns packed with 2µm particles for this analysis! The readily available and non-toxic nature of the sample and the low cost of Higgins Analytical cartridges has made the diet cola analysis an ideal choice for classroom purposes.

Reverse Phase Chromatography of Basic Compounds in Combinatorial Mixtures

In the example at the top of the next column, A and B are single compounds containing two identical building blocks. A-B and B-A represent positional isomers, each containing two building blocks.

This analysis was conducted on the crude liquid-phase reaction mixture. Each component contains multiple secondary

and tertiary amine functionality yet the combinatorial products can be rapidly chromatographed and exhibit no tailing on a 150x4.6mm HAISIL HL C18 column using a simple linear 5% to 100% MeCN/water 0.1% TFA gradient.

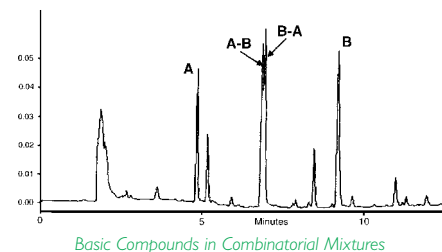

Basic Compounds in Combinatorial Mixtures

HAISIL HL C18
P/N LS-1546-C185

Speed and Selectivity for Ballistic Gradients on Complex Libraries

The relative importance of particle size and selectivity are graphically illustrated below by the high speed analysis of a six component combinatorial library on a HAISIL HL C18 5µm column and two competitor's C18 2µm columns. HAISIL HL with its high carbon loading and surface area of often works much better than expensive small particle size columns that are prone to plugging up more quickly.

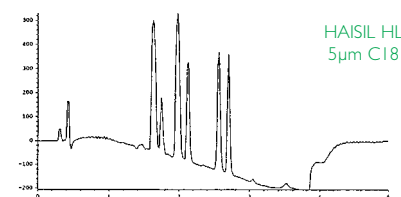

HAISIL HL
5µm C18

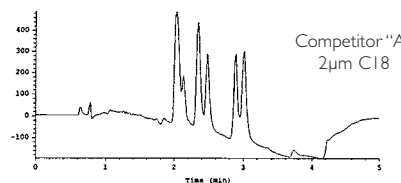

Competitor "A"
2µm C18

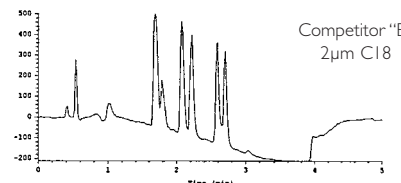

Competitor "B"
2µm C18





HEAVY Very Hydrophobic Loading

Phases	C18
Particle Sizes	4.5µm
Pore Size	100Å
Pore Volume	1.1mL/gm
Surface Area	450m ² /gm
%Carbon (w/w)	C18 = 22%
Phase type	Monofunctional & fully endcapped
Silica Class	Type B

Applications

Keeping in mind that relative retention (α) is a much more powerful term than plates (N) in the expression for resolution in chromatography, choosing a column with different selectivity is almost always more helpful than just going to a smaller particle size when trying to improve a difficult separation. Our new HEAVY columns provide the highest retention of any column we manufacture.

Guide to HEAVY Part Numbers

Vx-xxxx-C185 HEAVY C18 5µm

See Page 23 for complete Part Number information

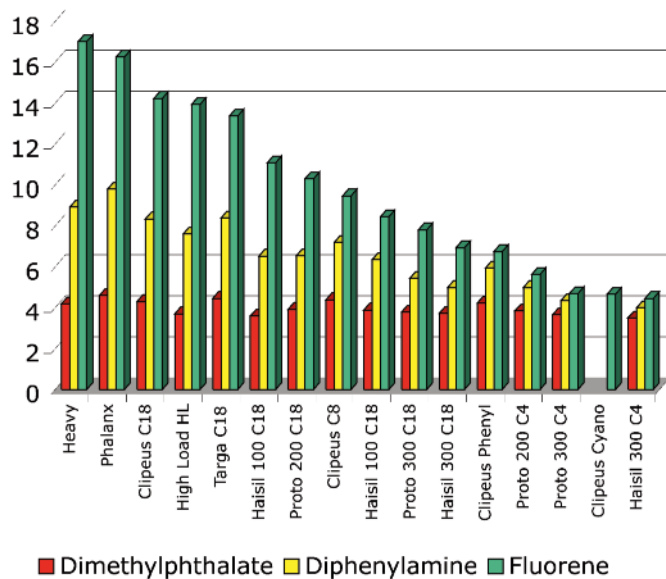

Relative hydrophobicity of Higgins Analytical's bonded phase sorbents.
 Conditions: 70% MeCN/Water



Why do HPLC columns plug up?

A large percentage of HPLC columns die because the back pressure builds up to

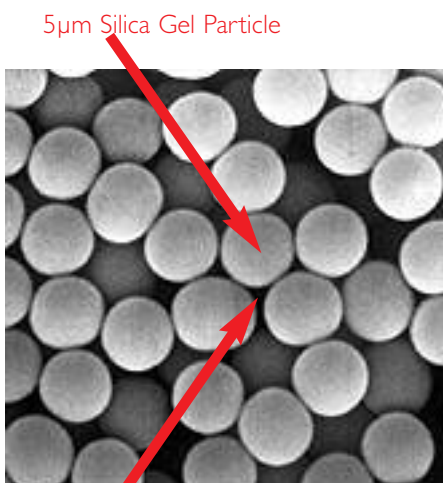

levels that exceed the instrument's practical limits. Most chromatographers (and many column manufacturers) believe this is because the inlet frit plugs up with particles. Actually, it is usually the packed-bed that becomes plugged by smaller than 1µm particles that pass through in-line filters and the 2µm inlet frits. The SEM above illustrates the relative sizes of particles and pores. Higgins Analytical offers a wide variety of guard cartridges that address this problem.

SPRITE is Designed to Operate in Either Flow Direction

A SPRITE is made of PEEK and titanium and can be connected directly to a sample injection valve or directly to a mass spectrometer's source inlet.



Using a PICCOLO as a Microbore Guard Column

PICCOLO columns are normally used as trap columns but since they are manufactured with the same techniques

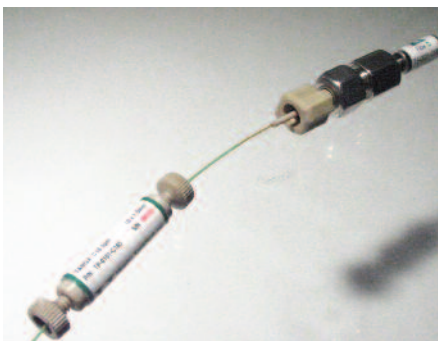

we use to pack microbore HPLC columns, they are very efficient. Their performance makes them ideal for use as short microbore HPLC column or as a guard for placed in front of another analytical microbore column. The chromatograms in the figure below illustrate typical performance when used in these unconventional modes.

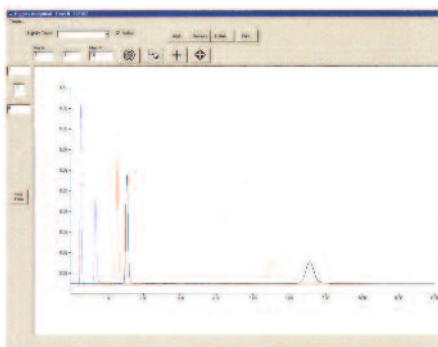

Piccolo Column performance as an Analytical Column and as a Guard Column

Blue Trace:
10x1mm Targa C18 5µm Piccolo Guard Column alone (P/N TP-0101-C185)

Red Trace:
50x1mm TARGA C18 5µm Analytical Column (P/N TS-0501-C185)

Black Trace:
10x1mm Guard coupled to 50x1mm Analytical Column

Peak #1: Dimethyl Phthalate Peak #2: Fluorene
60% MeCN/water; 50µL/min
System Variance ~6µL² at 50µL/min

The Role of Column Length in Gradient Separations

Changes in column length have a direct and linear effect on theoretical plates and analysis time in isocratic separations. Column length plays a less important role, however, in gradient techniques. The three chromatograms below illustrate how well packed short HPLC columns yield very similar peptide separations under identical gradient conditions.

For this study, the 2.1mm I.D. HAISIL 300 C18 5µm columns ranged from 250 to 100mm in length. While solvent and analysis time savings may be minimal, column cost savings can be significant when using as short a column as possible. Short columns also exhibit lower pressure at high flow rates.

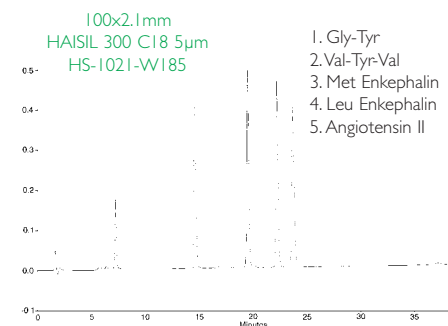
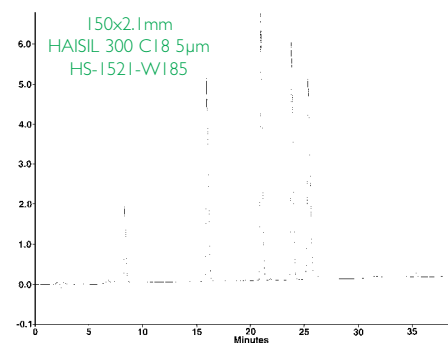
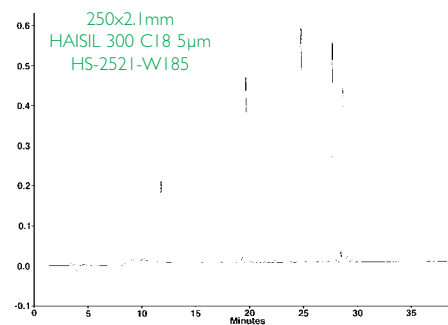

PROTO™ 200 More Selectivity and Resolution for Peptides

200

Phases	C4 and C18
Particle Sizes	4.5 and 10µm
Pore Size	200Å
Pore Volume	1.1 mL/gm
Surface Area	200m ² /gm
%Carbon (w/w)	C4. = 4.5%, C18= 14%
Phase type	Monofunctional & fully endcapped
Silica Class	Type B

Guide to PROTO 200 Part Numbers

Rx-xxxx-D045 PROTO 200 C4 5µm
 Rx-xxxx-D185 PROTO 200 C18 5µm

See Page 23 for complete Part Number information

Applications

300Å wide pore HPLC columns are traditionally used for biomolecule analysis since the molecular radii of large peptides and proteins are better matched than with smaller pore size columns (80 - 120Å) typically used for small molecule analysis. 300Å sorbents, however, have reduced surface area, thus less capacity and selectivity than would be had with smaller pore size materials. Higgins Analytical's new PROTO™ 200 presents a powerful alternative for the analysis of peptides of ~19kD and less.

Comparison of Phosphopeptide Purity Analysis

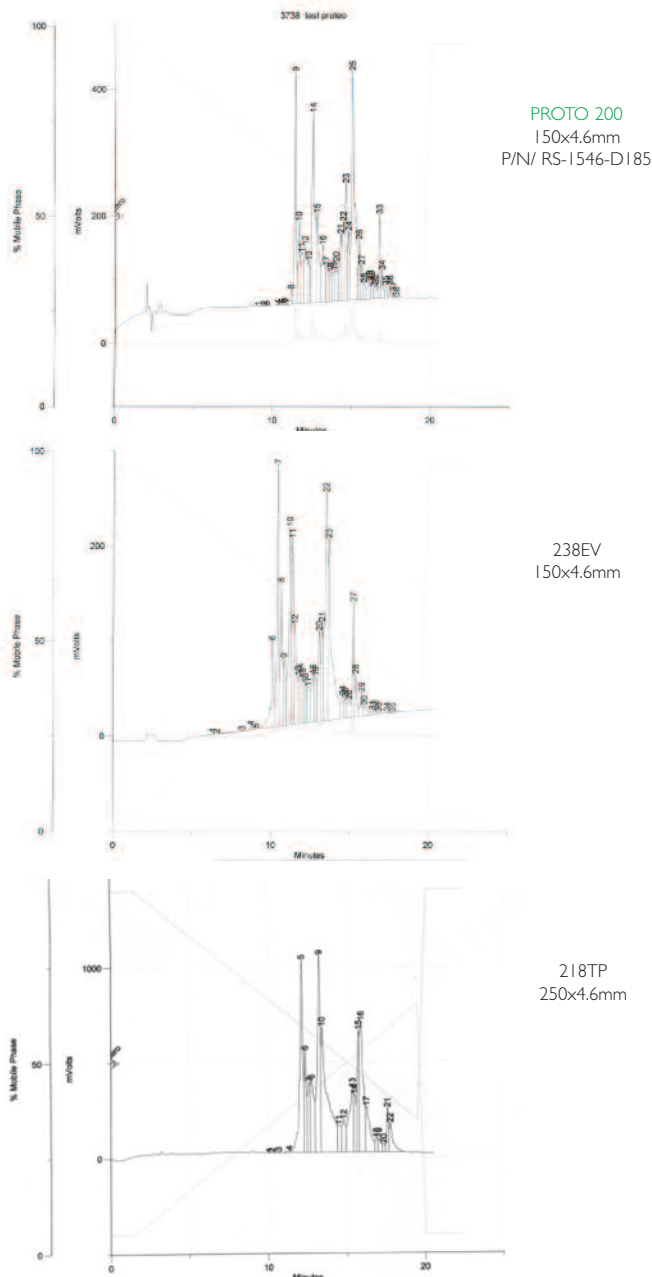

Phosphopeptide Purity Analysis

Peptide HPLC column performance, using the same gradient conditions, was evaluated on the PROTO™ 200 C18, a new peptide analysis column obtained from The Nest Group, Inc.. Against the industry standard, Grace/Vydac® 218TP C18, and their newer peptide chemistry, Everest® C18, the data show that the PROTO™ 200 C18 column has superior resolution to the 218TP chemistry and better resolution, especially for the more hydrophobic peptides, than the Everest® C18. In addition, the PROTO 200 columns can be run without TFA, which allows better detection when utilizing LC-MS.

Previously, the Everest chemistry had been shown by Grace/Vydac to be superior to all other wide pore columns, especially for the more hydrophobic peptides. However, the ready availability of the PROTO™ 200 peptide columns, in either C4 or C18 chemistries, and in capillary through preparative sizes, now allows researchers their first opportunity to save both time and money on a wider variety of applications, compared to the Grace/Vydac columns, and by extension to all other peptide columns.

Proto™ 200 C18 provides greater selectivity than the popular 300Å choice

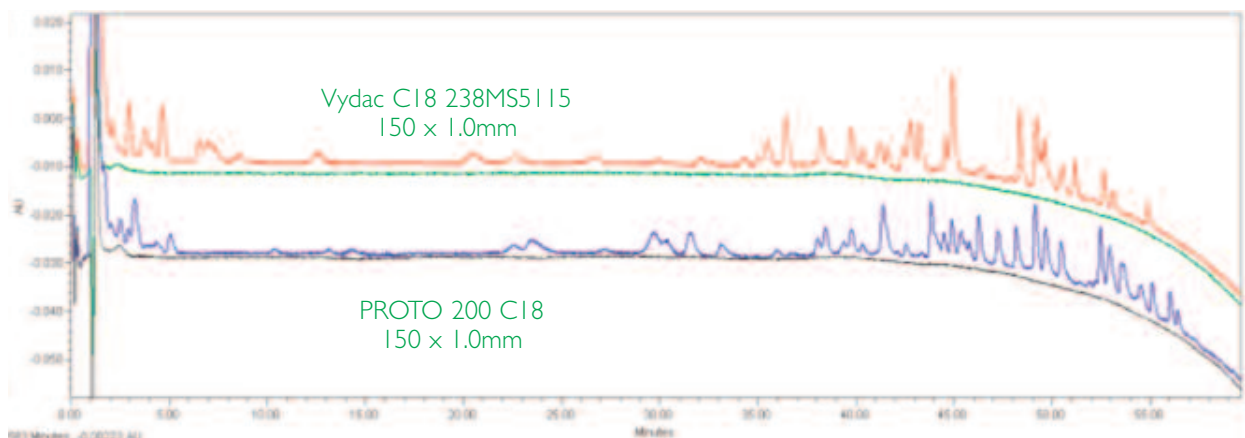

Tryptic Digest of Carbamidomethylated BSA (16h, 20 pMols on column).

Column Size:
150 x 1.0mm

Column Brand:			
Upper Chromatogram:	Vydac 300Å	238MS C18 5µm	P/N 238MS5115
Lower Chromatogram:	Higgins 200Å	Proto 200 C18 5µm	P/N RS-1501-D185

Conditions:
 A = 0.1% formic acid containing 0.01% TFA
 B = 0.085% formic acid in CH₃CN containing 0.01% TFA
 Initial 5 min isocratic hold at 5% B, then 60 min hyperbolic gradient to 65%B
 Flow 0.15 ml/min, Green & Black curves: Blank gradient profile

PROTO™ 300 Robust Bioseparations



Phases	C4 and C18
Particle Sizes	4.5 and 10µm
Pore Size	300Å
Pore Volume	0.9mL/gm
Surface Area	100m ² /gm
%Carbon (w/w)	C4 = 3%, C18= 8%
Phase type	Monofunctional & fully endcapped
Silica Class	Type B

Guide to PROTO 300 Part Numbers

Rx-xxxx-W045 PROTO 300 C4 5µm
 Rx-xxxx-W185 PROTO 300 C18 5µm

See Page 23 for complete Part Number information

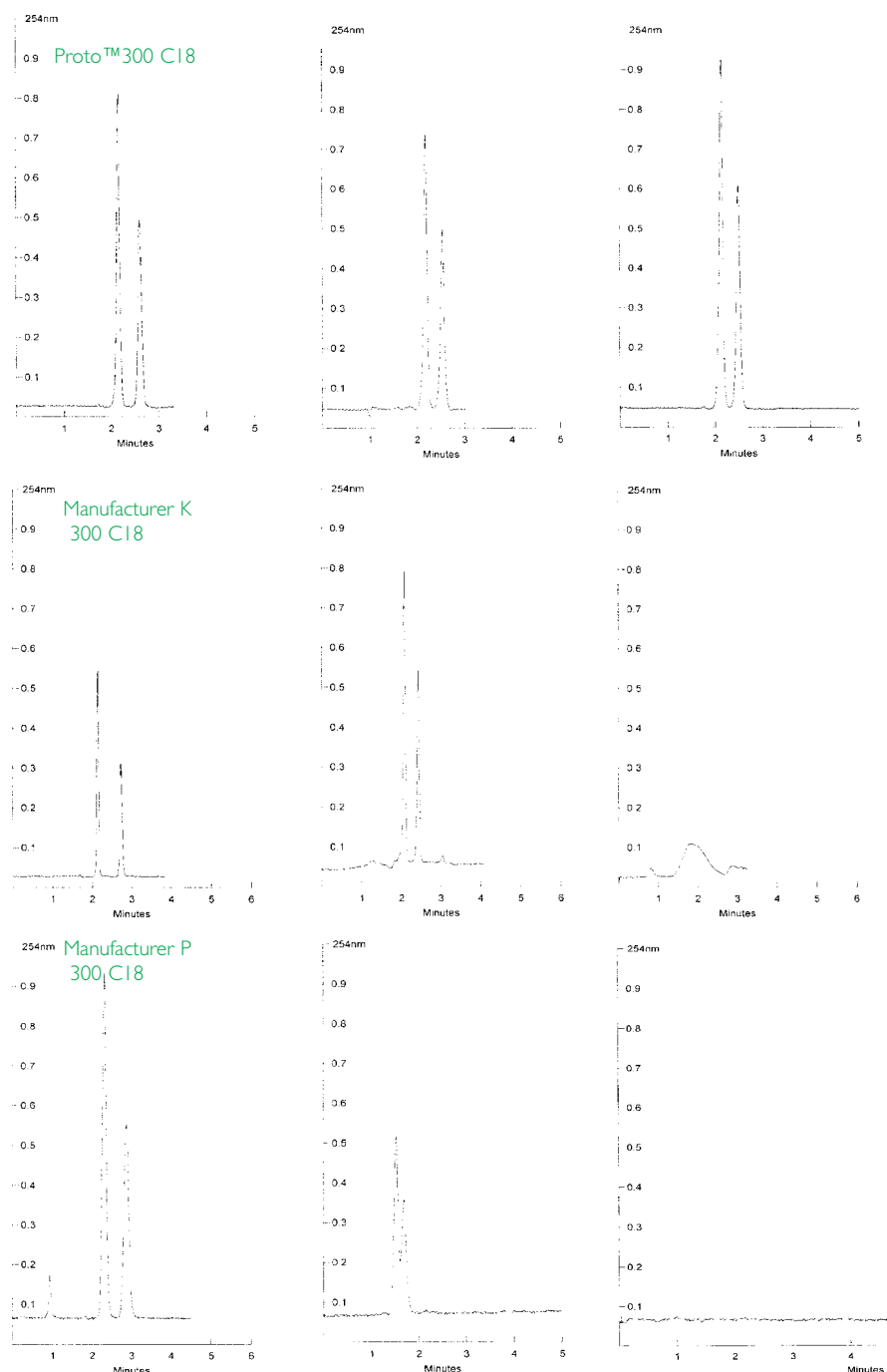

Applications

Low pH operating conditions and high pH column washing steps are typical bioprocessing operating conditions that can severely limit the lifetime and performance of widepore columns typically used for protein and peptide analysis. Higgins Analytical's new PROTO300 has high capacity for enhanced resolution and is robust enough to withstand prolonged use at extreme pH (1.5 - 10).

Stability Study Under Extremely Alkaline Conditions

Experimental:
 150 x 4.6mm columns were studied. All experiments were conducted on duplicate columns. Solutes used for performance measurement were dimethylphthalate and fluorene.

Step One:

Column stability and measurement precision was established for each column with multiple injections over 18hrs under neutral conditions (70% MeCN/water; 1mL/min). All columns were very stable. The chromatograms of a column from each manufacturer at the end of the 18 hour period are shown on the left hand side.

Step Two:

Each column was flushed with 70% MeCN/0.5N NaOH solution at 1mL/min for one hour (23°C). The columns were then purged and equilibrated under the standard neutral conditions then retested. The center chromatograms are the results of the first test after neutral equilibration

Step Three:

After the second step, the neutral test conditions were maintained for one hour and a repeat injection was made. The results are illustrated in the chromatograms on the right hand side of the figure.

While Higgins Analytical does not recommend flushing any silica-based HPLC column under such aggressive conditions, these data show the superior alkaline stability of Proto™ 300 C18.



PROTO™ 300 C4 for Protein Analysis

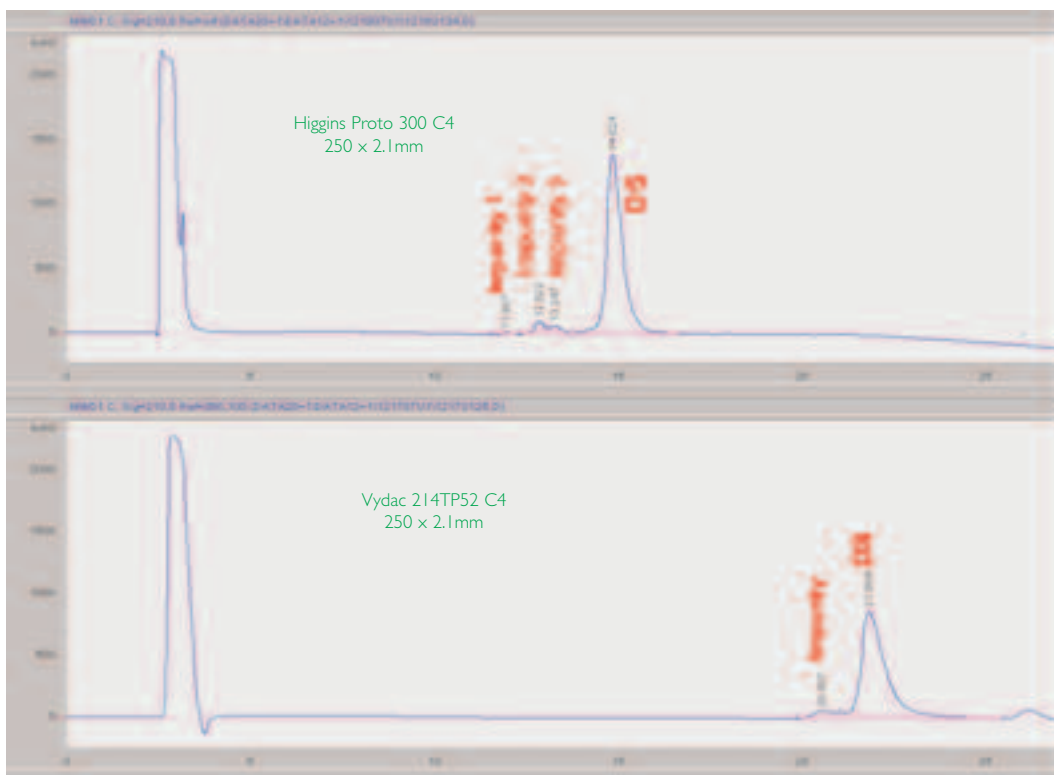

Column: 250 x 2.1mm Higgins P/N RS-2521-W045 (5µm, 300Å)
 Vydac P/N 214TP52 (5µm, 300Å)
 Mobile Phase: (A) 0.1%TFA in water; (B) 0.08%TFA in ACN, Flow Rate: 0.3min
 Start Conditions: 25%B, Linear Gradient Run Time 34min

Superior Resolution with PROTO™ 300 C4 for Protein Tryptic Digests

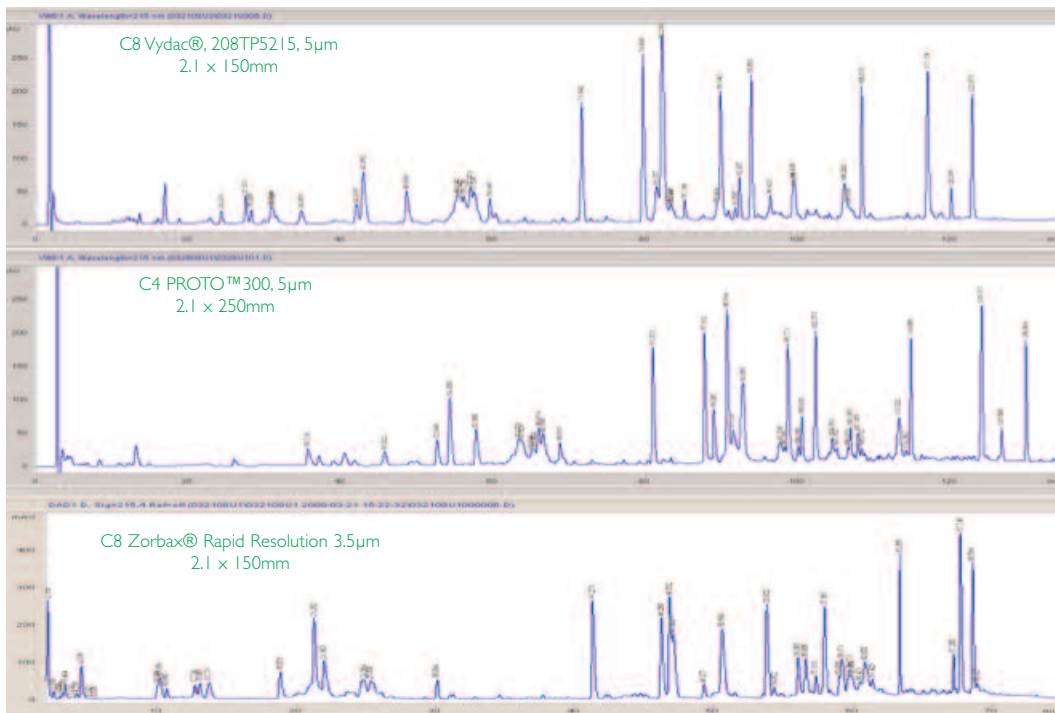

Higgins Analytical thanks Amos Heckendorf of The Nest Group (www.nestgrp.com) for these data.





PHALANX Ultra High Density End Capping

Phases	C18
Particle Sizes	3, 4.5, 10µm
Pore Size	100Å
Pore Volume	1.1mL/gm
Surface Area	430m ² /gm
%Carbon (w/w)	C18 = 18%
Phase type	Monofunctional & fully endcapped
Silica Class	Type B

NEW
3 & 10µm

Guide to Phalanx Part Number

Px-xxxx-C185 Phalanx C18 5µm
See Page 23 for complete Part Number information

Phalanx HPLC columns and cartridges facilitate the development of robust assays for challenging analytes

Unique Features:

- Ideal for Basic and Acidic Analytes
- Wide pH Range Stability
- High Capacity
- No secondary Si-OH interaction
- No metal contamination
- Extreme hydrophobicity range

Standard Sizes:

- Special products for LC-MS
- 0.075 - 20mm I.D. range
- Wide range of HPLC Cartridge and Column types
- PEEK/titanium as well as stainless steel formats

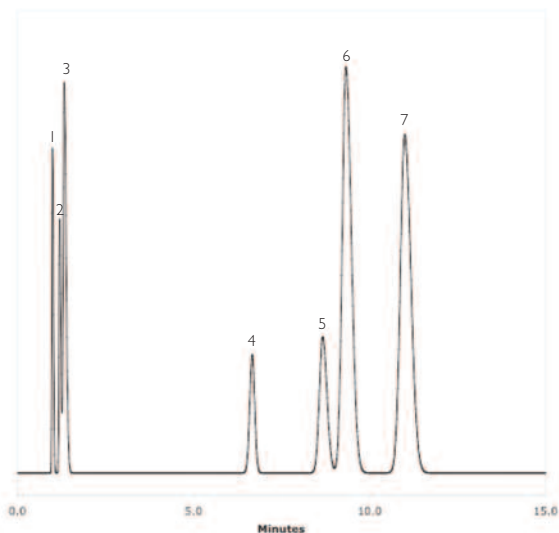

High Selectivity

Wide range of solutes resolve quickly on a short HPLC column

Phalanx C18, 100x4.6mm, P/N: PS-1046-C185

(1) Uracil, (2) Caffeine, (3) Phenol, (4) n-Butylbenzene, (5) o-Terphenyl, (6) n-Amylbenzene, (7) Triphenylene
80% MeOH/water; 1mL/min

Applications

Phalanx is uniquely suitable for the efficient analysis of both acidic and basic analytes. In addition, its high capacity, good stability at high pH, and fast equilibration at extreme ranges of hydrophobicity make Phalanx a powerful option for challenging separation problems.

Phalanx is Higgins Analytical's latest addition to a family of unique high performance HPLC sorbents. The novel end capping technology of this new sorbent is a continuation of the pioneering approach taken in 1996 when we introduced Targa®, the first HPLC sorbent specifically designed for efficient LC-MS applications without TFA.



Based on an ultrapure, Type-B silica backbone, Phalanx has a relatively high surface area of 430 m²/gm, but its very tight pore size distribution eliminates the undesirable side effects of micropores that often plague other high surface materials.

Optimum for Basic and Acidic compounds: Many modern HPLC sorbents employ embedded polar functionality. While these secondary structures can provide unique selectivity and eliminate undesirable solute/sorbent interaction, they often compromise the useful range of solutes or buffers that can be used. The figure on the left and those on page 2 illustrate that Phalanx columns produce symmetrical peaks during the analysis of basic, neutral, and acidic compounds.

Wide pH operating range: The unique endcapping reduces acid/base hydrolysis of the bonded phase and greatly reduces silica solvation at high pH.



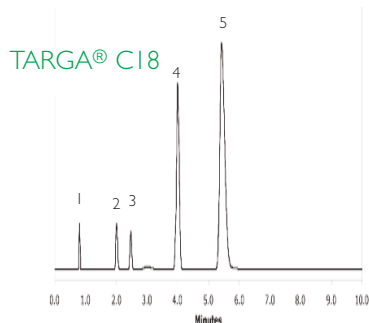

TARGA® C18

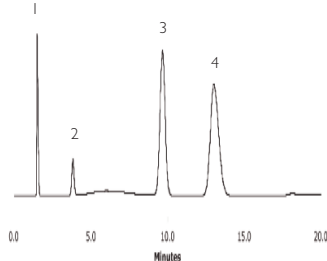

Good Peak Symmetry for Basic Compounds

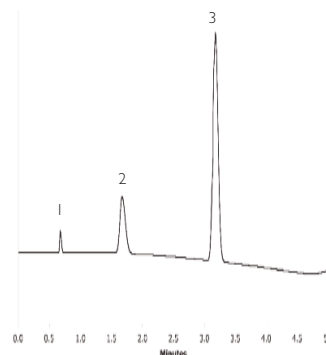

Unbuffered Pyridine Test for Free Silanol Activity

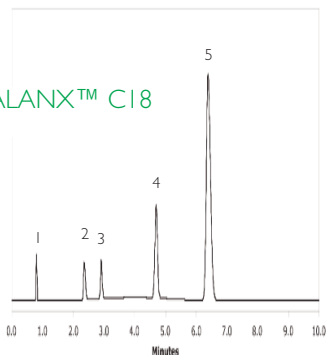

PHALANX™ C18

The very low solute/sorbent interaction of Phalanx C18 is clearly illustrated by the analysis of basic compounds on a short 5cm cartridge column.

Phalanx C18, 50x2.1mm, P/N: PK-0521-C185

(1) Propanediol, (2) Diphenyldramine, (3) Acenaphthene, (4) Amitiptyline.
65% MeOH/water 20mM KH₂PO₄ (pH 7.0), 200µL/min

A very sensitive test for residual silanols produces a symmetrical pyridine peak in a low organic mobile phase without buffers.

Phalanx C18, 50x2.1mm, P/N: PK-0521-C185

(1) Uracil, (2) Phenol, (3) Pyridine
40% MeCN/water, 200µL/min

NIST Test Mix for Metal Activity and Residual Silanols

Quinizarin, a strong metal chelator; and amitriptyline, a very sensitive solute for residual silanols, both elute with good recovery and symmetrical peaks on both Targa and Phalanx C18 columns.

Targa® C18, 150x4.6mm, P/N: TS-1546-C185

Phalanx™ C18, 150x4.6mm, P/N: PS-1546-C185

(1) Uracil, (2) Toluene, (3) Ethylbenzene, (4) Quinizarin, (5) Amitiptyline.

80% MeOH/buffer, 1.5mL/min

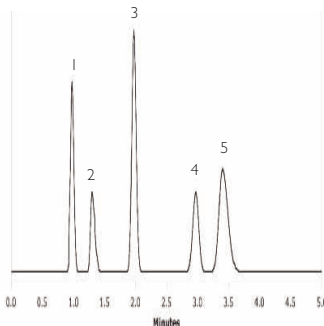

Nucleosides

Like its cousin Targa, Phalanx's unique end-capping chemistry works equally well at extreme hydrophilic and hydrophobic ranges.

Phalanx C18, 50x2.1mm, P/N: PK-0521-C185

(1) Cytosine, (2) Uracil, (3) Cytidine, (4) Uridine, (5) Thymine.
100% Water, 1.0mL/min

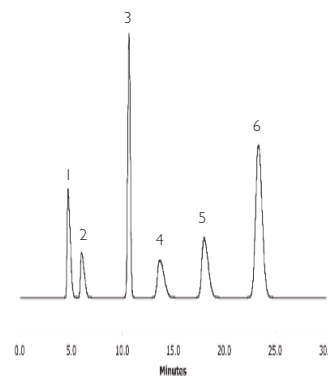

Tricyclic Antidepressants

The very low solute/sorbent interaction of Phalanx C18 is clearly illustrated by the analysis of basic compounds on a 100x4.6mm HPLC column.

Phalanx C18, 100x4.6mm, P/N: PS-1046-C185

(1) Desipramine, (2) Nortriptyline, (3) Acenaphthene, (4) Imipramine, (5) Amitriptyline, (6) Trimipramine.

70% MeOH/water 20mM KH₂PO₄ (pH 7.0), 1.0mL/min

See page 28 for an interesting comparison of PHALANX to KROMASIL C18 for an analysis of a pharmaceutical drug.





TARGA A Uniquely Shielded Surface

Phases	C8 and C18
Particle Sizes	3, 4.5 and 10µm
Pore Size	120Å
Pore Volume	0.8mL/gm
Surface Area	330m ² /gm
Carbon%(w/w)	C18 = 18%
Phase type	Monofunctional with a unique polar and bulky end-capping
Silica Class	Type B

Guide to TARGA Part Numbers

Tx-xxxx-C183 Targa C18 3µm

Tx-xxxx-C185 Targa C18 5µm

See Page 23 for complete Part Number information

Peptide Mapping without TFA

The following chromatograms illustrate the differences in selectivity for peptide maps of cytochrome-C when using 0.05% TFA or 0.05% acetic acid buffer in

While TARGA columns give exceptional performance without TFA buffer, it does not mean that you are precluded from using it. In fact, the changes in selectivity

Applications

TARGA columns and cartridges are ideal for applications requiring an absence of secondary solute-silanol interaction. Basic and acidic drugs and peptides can be chromatographed efficiently with little or no buffer. Targa columns are particularly well suited for LC/MS applications where acetic acid or formic acid can be substituted for TFA resulting in significant increase in signal. While TFA is not required, it does not preclude its use on TARGA columns. TARGA exhibits extremely fast equilibration kinetics from high to low organic phase compositions. It works well in 100% aqueous conditions for hydrophilic applications also.

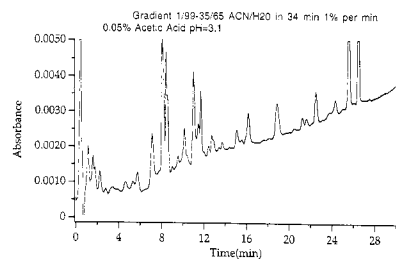
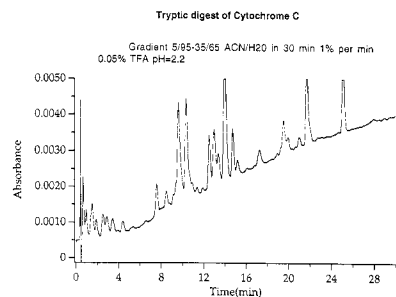

1%/min acetonitrile gradient on a short 50x1.0mm TARGA C18 column. Both dilute buffer examples are characterized by sharp peaks and no tailing.

LC-MS without TFA

Researchers have shown that Higgins Analytical's TARGA C8 and C18 phases have an extremely well protected silanol surface. An acetonitrile/water 1%/min gradients with as little as 0.05% acetic acid gives a very satisfactory peptide map on a short 5cm x 1mm TARGA C18 column. The ability to buffer with acetic or formic acid rather than TFA greatly enhances signals for LC/MS techniques.

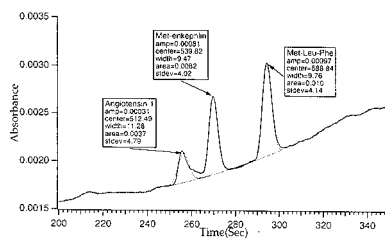

Basic Peptides
with 0.1% Acetic Acid pH 3.1
TARGA C18 5µm 50x1.0mm

that comes with changing buffer acids can be a powerful tool for separation optimization. Notice how the peptide elution orders change between the acetic acid (above) and TFA (below) buffered chromatogram. This is due to the differences in pH of the acetic acid and TFA mobile phase.

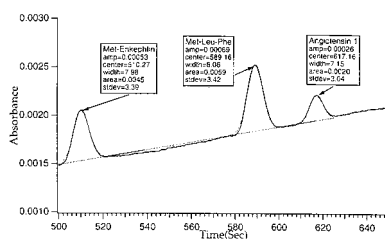

Basic Peptides
with 0.1% TFA pH 2.2
TARGA C18 5µm 50x1.0mm

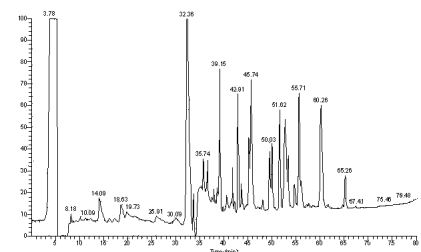

Tryptic Map of Human Ocular Lens Proteins
beta A1 crystallin and gamma S crystallin

TARGA C18 5µm 150x0.5mm
P/N/TS-15M5-C185

Solvent A: 0.1% Acetic Acid
Solvent B: 0.1% Acetic Acid, 65% MeCN
0 - 50% B in 60min, 50 - 100%B in 15min

Sample is a tryptic digest of a 2D electrophoresis separated spot digested from PDVF membrane. The two ocular proteins are ~25kD. The LC/MS zoom scan below confirms the peak at 39.15min is singly charged, and software interpretation of the MS/MS scan at the bottom confirms the 1156.6 ion as residues 84-94 in human gamma S crystallin.

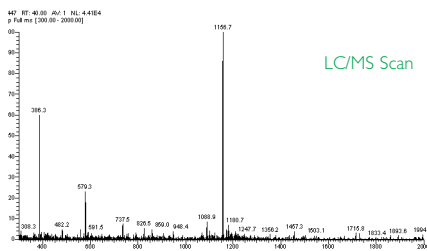

LC/MS Scan

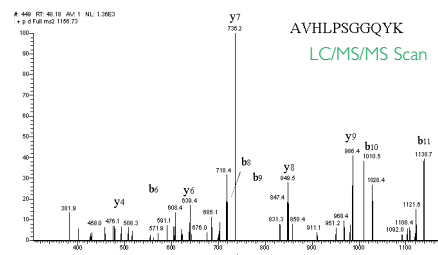

AVHLPSSGGQYK
LC/MS/MS Scan



Unrivaled End Capping Technology Efforts to eliminate solute-silanol

Targa HPLC columns are true to the Latin root of their name. TARGA, meaning "shield," is precisely the effect the unique bonded phase has on the silica's silanol surface.

Many HPLC column manufacturers illustrate the performance of their columns packed with inert, base deactivated, "Type B silica" bonded phases by the chromatographic behavior of polar compounds such as pyridine. Performance claims can be misleading, however, when mobile phases are buffered to low pH or when they contain high percentages of organic solvent.

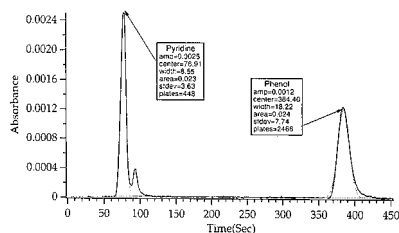

Unbuffered 20% MeCN/water

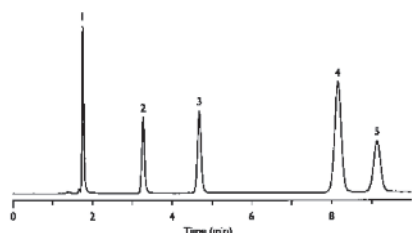

Analgesics and Anti-Inflammatories

TARGA C18 5µm 150x4.6mm
Part Number TS-1546-C185
45% MeCN/20mM NaH₂PO₄ pH3.2 1mL/min 260nm

- 1. Acetaminophen
- 2. Indoprofen
- 3. Naproxan
- 4. Indomethacin
- 5. Ibuprofen

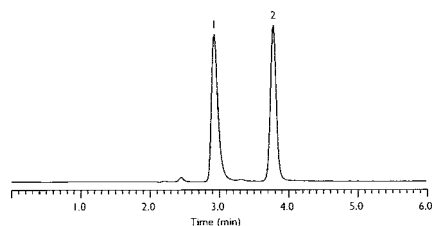

Anti-Hypertensives

TARGA C18 5µm 150x4.6mm
Part Number TS-1546-C185
25% MeCN/20mM NaH₂PO₄ pH3.2 1mL/min 260nm

- 1. Triamterene
- 2. Hydrochlorothiazide

Favorable Kinetics at Aqueous or Organic Mobile Phase Extremes

The bulky moiety used for end capping TARGA C8 and C18 sorbents present other valuable selectivity characteristics in addition to the extreme inertness to basic and acidic compounds. Long chain alkane bonded phases collapse under low organic phase conditions on most reverse phase HPLC columns causing poor reproducibility and slow reequilibration. Fast gradients can be run on TARGA columns from initial 100% aqueous conditions with fast cycle times and very good run-to-run reproducibility. TARGA columns can also be run isocratically in 100% aqueous conditions for carbohydrate analysis, or with only a few percent organic modifier to achieve selectivity on solutes that are retained under typical reverse phase conditions.

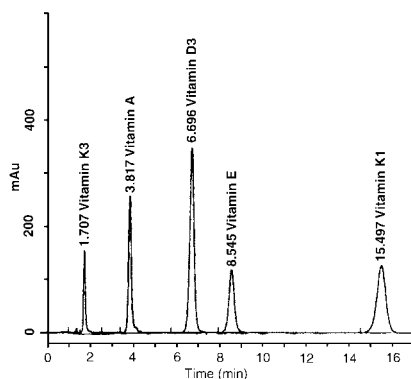

Fat-Soluble Vitamin Assay

TARGA C18 5µm 100x2.1mm
Part Number TS-1021-C185
3% water in MeOH mobile phase
200µl/min, diode array detection

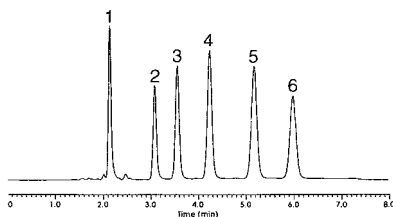

Analysis of Very Polar Antibacterials with a Highly Aqueous Mobile Phase

- 1. Vancomycin, 2. Cefotaxime, 3. Cefazolin

TARGA C18 100x2.1mm TS-1021-C185
Mobile Phase: 92% Water with 0.1% TFA pH2.5,
8% MeOH, DAD at 230nm

TARGA's Superior Hydrophilic Reverse Phase Properties

Several manufacturers offer reverse phase column products with imbedded polar functionality intended to enhance the chromatography of hydrophilic compounds like those illustrated in the previous antibacterial example. Unfortunately, most of these approaches introduce undesirable secondary effects that preclude their use with acidic or basic solutes unlike TARGA with its unique bonded phase.

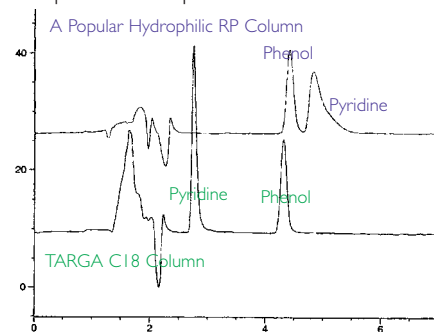

TARGA Compared to a Competitor's Hydrophilic Column
150x4.6mm, 20% MeCN/water (unbuffered) 1mL/min

Trace Catecholamine Analysis

In vivo microdialysis present a challenge to both instrumentation and column design, especially when depended upon as a tool for routine analysis. The chromatogram below illustrates rat hypothalamus microdialysis analysis for 5HT. Researchers report that the 100x2.1mm Higgins Analytical PEEK and titanium TARGA C18 column operates routinely at 0.2 - 100 nM detection levels.

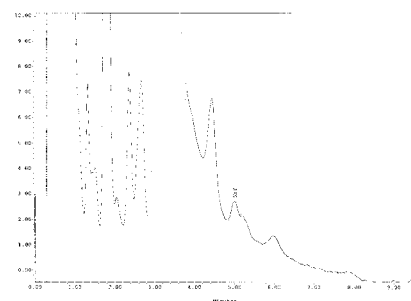

5HT Analysis of Rat Hypothalamus Dialysate

TARGA C18 5µm 100x2.1mm
P/N TS-1021-C185

NaH₂PO₄ 0.15M, OSA 0.74mM, EDTA 0.1mM
pH 2.87 (orthophosphoric acid) 2% IPA

Instrumentation: Flux Rheos Isocratic Pump, In-line Solvent Degasser; Spark Holland Triathlon Autosampler; Antec INTRO EC Detector

Detection levels of 0.2 - 100 nM are routinely achieved.



PLRP-S
PL-SAX
PL-SCX
PL-WAX
PL-WCX

POLYMERIC

Unique Features:

- pH 1 to 14 operating range
- Uniform hydrophobicity
- Absence of any silanols
- Very high selectivity
- Orthogonality for 2D methods
- Mechanically and chemically robust

Physical Properties:

- PLRP-S
Reverse phase media
100Å, 300Å, 1,000Å and 4,000Å Pore sizes
3µm and 5µm particle sizes
- PL-SAX
Strong anion exchanger $-N(CH_3)_3^+$
1,000Å and 4,000Å Pore sizes
5µm particle size
- PL-SCX
Strong cation exchanger $-SO_3^-$
1,000Å and 4,000Å Pore sizes
5µm particle size
- PL-WAX
Weak anion exchanger
1,000Å and 4,000Å Pore sizes
5µm particle size
- PL-WCX
Weak cation exchanger
1,000Å and 4,000Å Pore sizes
5µm particle size

Guide to POLYMERIC Part Numbers

PLx-xxxx-RP13	PLRP-S 100Å 3µm
PLx-xxxx-RP33	PLRP-S 300Å 3µm
PLx-xxxx-RP1K5	PLRP-S 1,000Å 5µm
PLx-xxxx-RP4K5	PLRP-S 4,000Å 5µm
PLx-xxxx-SAX1K5	P-SAX 1,000Å 5µm
PLx-xxxx-SAX4K5	P-SAX 4,000Å 5µm
PLx-xxxx-WAX1K5	P-WAX 1,000Å 5µm
PLx-xxxx-WAX4K5	P-WAX 4,000Å 5µm
PLx-xxxx-SCX1K5	P-SCX 1,000Å 5µm
PLx-xxxx-SCX4K5	P-SCX 4,000Å 5µm
PLx-xxxx-WCX1K5	P-WCX 1,000Å 5µm
PLx-xxxx-WCX4K5	P-WCX 4,000Å 5µm

See Page 23 for complete Part Number information

Applications

Higgins Analytical now manufactures a wide range of small column and cartridge formats with polymeric phases from Polymer Labs Ltd.

This powerful array of media provides chromatographers with unique solutions for challenging HPLC applications. In addition to not having the pH limitations inherent to all silica-based sorbents, these polymeric phases provide an orthogonal tool for addressing difficult protocols and multidimensional techniques. The relatively high capacity and unique selectivity of these robust phases can often provide a separation under harsh conditions that cannot be addressed with popular silica-based columns.

The rigid porous structure and chemical stability of Polymer Labs media make them compatible with the wide range of organic solvents typically used in modern HPLC methods. In addition to insuring long mechanical and chemical life times, this robustness also provides an ability for these polymeric phases to be rejuvenated under chemical and thermal conditions that would be unthinkable to subject a conventional HPLC column.

The uniform hydrophobicity and absence of acidic silanols make this family of polymeric phases ideal for many biomolecule separations.

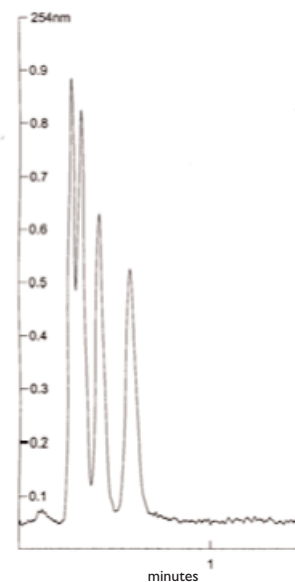

High Speed Paraben Separation on a 1cm x 1mm PLRP-S
P/N PLP-0101-RP13

(1) Methylparaben, (2) Ethylparaben,
(3) Propylparaben, (4) Butylparaben
50% MeCN/water; 50µL/min

HPLC Columns and Cartridges

Higgins Analytical HPLC column product part numbers are based on a 2-4-4 character pattern. For example:

TS-1521-C185

is the part number for a conventional 15cm x 2.1mm stainless steel column packed with Targa C18 5µm sorbent.

The two character prefix indicates sorbent and hardware type.

Prefix Character 1 (Sorbent)
nX-XXXX-XXXX

C = CLIPEUS
H = HAILSIL 100 or HAILSIL 300
L = HAILSIL HL
P = PHALANX
R = PROTO 200 or 300
T = TARGA
V = HEAVY

Prefix Character 2 (Hardware)
Xn-XXXX-XXXX

C = Capellini capillary column
S = Stainless steel HPLC Column
P = PEEK HPLC column
F = Stainless steel cartridge column
K = PEEK cartridge column
R = Sprite Direct-Connect column

Note: Microbore columns have the second character, S, like stainless steel columns, but they are glass lined.

The four center characters indicate the column or cartridge length (cm) and internal diameter (mm).

Center Characters 1 and 2 (Length)
XX-nnXX-XXX

03 = 3cm
04 = 4cm
05 = 5cm
07 = 7.5cm
10 = 10cm
12 = 12.5cm
15 = 15cm
20 = 20cm
22 = 22cm
25 = 25cm
30 = 30cm
50 = 50cm

The four center characters indicate the column or cartridge length (cm) and internal diameter (mm).

Center Characters 3 and 4 (I.D.)
XX-XXnn-XXXX

07 = 0.075mm
M1 = 0.1mm
15 = 0.15mm
M3 = 0.3mm
M5 = 0.5mm
M8 = 0.8mm
01 = 1.0mm
21 = 2.1mm
30 = 3.0mm
32 = 3.2mm
40 = 4.0mm
46 = 4.6mm
10 = 10mm
20 = 20mm

The four character suffix indicates sorbent chemistry and particle size.

Suffix Characters 1 to 3 (Phase)
XX-XXXX-nnnX

C04 = Butyl or C4
C08 = Octyl or C8
C18 = ODS or C18
CNP = Cyano or Nitrite
D04 = 200Å C4
D18 = 200Å C18
M08 = HAILSIL 100 C8
M18 = HAILSIL 100 C18
NH2 = Amino
PHN = Phenyl
SIL = Silica Gel
W04 = 300Å C4
W08 = 300Å C8
W18 = 300Å C18

Suffix Character 4 (Particle Size)
XX-XXXX-XXXn

1 = 10µm
2 = 10 - 15µm
3 = 3 or 3.5µm
5 = 4.5 or 5µm
7 = 15 - 20µm

Notes:

- (1) Standard configurations are highlighted.
- (2) Polymeric phases have a 3-4-6 pattern. The first two prefix characters are PL. The last character denotes particle size.

PLx-xxxx-xxxxxx

Cartridge Holders

Guards

Two types of holders for 2cm long PEEK and s.s. cartridges are offered.

HK-GUARD-FF Female/Female
HK-GUARD-FM Direct Connect

Analytical Cartridge Holders

Three internal diameters (2.1, 3.2, and 4.6mm) and three lengths are offered.

HK-HOLD-40 for 4cm long cartridge
HK-HOLD-50 for 5cm long cartridge
HK-HOLD-100 for 10cm long cartridge

HAISpeed 10 Cartridge Holders

These 10mm i.d. cartridges are offered in three lengths.

10-HOLD-30 for 3cm long cartridge
10-HOLD-50 for 5cm long cartridge
10-HOLD-100 for 10cm long cartridge

HAISpeed 20 Cartridge Holder

20mm i.d. prep guard cartridges require a 25mm long cartridge holder.

20-HOLD-25 for 20 x 25mm cartridge

HPLC Columns

Wide Range of Stainless Steel HPLC COLUMNS



Widest Range of Hardware Types and Sizes Available Anywhere

Higgins Analytical manufactures the widest range of column formats in the widest range of hardware types available anywhere. Conventional HPLC columns are offered in stainless steel hardware. Frit materials include stainless steel, Carpenter C, titanium. Standard lengths range from 3.3cm to 25 cm. Custom columns are routinely manufactured in odd length ranging from 3.3 to 50cm. The internal diameters of our entire HPLC column and cartridge offering range from 75µm to 20mm, over two orders of magnitude.

Guide to Some Standard HPLC Column Part Numbers

xS-xxxx-xxxx	Stainless Steel (ss) column	
xP-xxxx-xxxx	PEEK column	
xS-03xx-xxxx	3.5cm ss column	Shortest standard size
xS-25xx-xxxx	25cm ss column	Longest standard size
xP-05xx-xxxx	5cm PEEK column	Shortest standard size
xP-25xx-xxxx	25cm PEEK column	Longest standard size
xS-xx21-xxxx	2.1mm ss I.D.	Smallest standard I.D.
xP-xx21-xxxx	2.1mm PEEK I.D.	Smallest standard I.D.
xS-xx46-xxxx	4.6mm ss I.D.	Popular standard I.D.
xP-xx46-xxxx	4.6mm PEEK I.D.	Popular standard I.D.

See Page 23 for complete Part Number information

CLIQUEUS Analytical Columns - Stainless Steel



CLIQUEUS C8 5µm		4.6, 4.0, 3.0, and 2.1mm I.D. s.s. columns							
30x4.6mm		50x4.6mm		100x4.6mm		150x4.6mm		250x4.6mm	
CS-0346-C085	\$270	CS-0546-C085	\$280	CS-1046-C085	\$290	CS-1546-C085	\$325	CS-2546-C085	\$350
30x4.0mm		50x4.0mm		100x4.0mm		150x4.0mm		250x4.0mm	
CS-0340-C085	\$270	CS-0540-C085	\$280	CS-1040-C085	\$290	CS-1540-C085	\$325	CS-2540-C085	\$350
30x3.0mm		50x3.0mm		100x3.0mm		150x3.0mm		250x3.0mm	
CS-0330-C085	\$270	CS-0530-C085	\$280	CS-1030-C085	\$290	CS-1530-C085	\$325	CS-2530-C085	\$350
30x2.1mm		50x2.1mm		100x2.1mm		150x2.1mm		250x2.1mm	
CS-0321-C085	\$270	CS-0521-C085	\$280	CS-1021-C085	\$290	CS-1521-C085	\$325	CS-2521-C085	\$350
CLIQUEUS C18 10µm		4.6mm I.D. s.s. columns							
30x4.6mm		50x4.6mm		100x4.6mm		150x4.6mm		250x4.6mm	
CS-0346-C181	\$245	CS-0546-C181	\$260	CS-1046-C181	\$270	CS-1546-C181	\$295	CS-2546-C181	\$320
CLIQUEUS C18 5µm		4.6, 4.0, 3.0, and 2.1mm I.D. s.s. columns							
30x4.6mm		50x4.6mm		100x4.6mm		150x4.6mm		250x4.6mm	
CS-0346-C185	\$270	CS-0546-C185	\$280	CS-1046-C185	\$290	CS-1546-C185	\$325	CS-2546-C185	\$350
30x4.0mm		50x4.0mm		100x4.0mm		150x4.0mm		250x4.0mm	
CS-0340-C185	\$270	CS-0540-C185	\$280	CS-1040-C185	\$290	CS-1540-C185	\$325	CS-2540-C185	\$350
30x3.0mm		50x3.0mm		100x3.0mm		150x3.0mm		250x3.0mm	
CS-0330-C185	\$270	CS-0530-C185	\$280	CS-1030-C185	\$290	CS-1530-C185	\$325	CS-2530-C185	\$350
30x2.1mm		50x2.1mm		100x2.1mm		150x2.1mm		250x2.1mm	
CS-0321-C185	\$270	CS-0521-C185	\$280	CS-1021-C185	\$290	CS-1521-C185	\$325	CS-2521-C185	\$350

CLIQUEUS Analytical Columns - Stainless Steel



CLIQUEUS Cyano 5µm		4.6, 4.0, 3.0, and 2.1mm I.D. s.s. columns							
30x4.6mm		50x4.6mm		100x4.6mm		150x4.6mm	250x4.6mm		
CS-0346-CNP5	\$280	CS-0546-CNP5	\$290	CS-1046-CNP5	\$300	CS-1546-CNP5	\$345	CS-2546-CNP5	\$365
30x4.0mm		50x4.0mm		100x4.0mm		150x4.0mm	250x4.0mm		
CS-0340-CNP5	\$280	CS-0540-CNP5	\$290	CS-1040-CNP5	\$300	CS-1540-CNP5	\$345	CS-2540-CNP5	\$365
30x3.0mm		50x3.0mm		100x3.0mm		150x3.0mm	250x3.0mm		
CS-0330-CNP5	\$280	CS-0530-CNP5	\$290	CS-1030-CNP5	\$300	CS-1530-CNP5	\$345	CS-2530-CNP5	\$365
30x2.1mm		50x2.1mm		100x2.1mm		150x2.1mm	250x2.1mm		
CS-0321-CNP5	\$280	CS-0521-CNP5	\$290	CS-1021-CNP5	\$300	CS-1521-CNP5	\$345	CS-2521-CNP5	\$365

CLIQUEUS Phenyl 5µm		4.6, 4.0, 3.0, and 2.1mm I.D. s.s. columns							
30x4.6mm		50x4.6mm		100x4.6mm		150x4.6mm	250x4.6mm		
CS-0346-PHN5	\$280	CS-0546-PHN5	\$290	CS-1046-PHN5	\$300	CS-1546-PHN5	\$345	CS-2546-PHN5	\$365
30x4.0mm		50x4.0mm		100x4.0mm		150x4.0mm	250x4.0mm		
CS-0340-PHN5	\$280	CS-0540-PHN5	\$290	CS-1040-PHN5	\$300	CS-1540-PHN5	\$345	CS-2540-PHN5	\$365
30x3.0mm		50x3.0mm		100x3.0mm		150x3.0mm	250x3.0mm		
CS-0330-PHN5	\$280	CS-0530-PHN5	\$290	CS-1030-PHN5	\$300	CS-1530-PHN5	\$345	CS-2530-PHN5	\$365
30x2.1mm		50x2.1mm		100x2.1mm		150x2.1mm	250x2.1mm		
CS-0321-PHN5	\$280	CS-0521-PHN5	\$290	CS-1021-PHN5	\$300	CS-1521-PHN5	\$345	CS-2521-PHN5	\$365

CLIQUEUS Silica 5µm		4.6, 4.0, 3.0, and 2.1mm I.D. s.s. columns							
30x4.6mm		50x4.6mm		100x4.6mm		150x4.6mm	250x4.6mm		
CS-0346-SIL5	\$245	CS-0546-SIL5	\$250	CS-1046-SIL5	\$260	CS-1546-SIL5	\$295	CS-2546-SIL5	\$315
30x4.0mm		50x4.0mm		100x4.0mm		150x4.0mm	250x4.0mm		
CS-0340-SIL5	\$245	CS-0540-SIL5	\$250	CS-1040-SIL5	\$260	CS-1540-SIL5	\$295	CS-2540-SIL5	\$315
30x3.0mm		50x3.0mm		100x3.0mm		150x3.0mm	250x3.0mm		
CS-0330-SIL5	\$245	CS-0530-SIL5	\$250	CS-1030-SIL5	\$260	CS-1530-SIL5	\$295	CS-2530-SIL5	\$315
30x2.1mm		50x2.1mm		100x2.1mm		150x2.1mm	250x2.1mm		
CS-0321-SIL5	\$245	CS-0521-SIL5	\$250	CS-1021-SIL5	\$260	CS-1521-SIL5	\$295	CS-2521-SIL5	\$315

HAISIL 100 Analytical Columns - Stainless Steel



HAISIL 100 C8 5µm		4.6, 4.0, 3.0, and 2.1mm I.D. s.s. columns							
30x4.6mm		50x4.6mm		100x4.6mm		150x4.6mm	250x4.6mm		
HS-0346-M085	\$235	HS-0546-M085	\$245	HS-1046-M085	\$255	HS-1546-M085	\$260	HS-2546-M085	\$270
30x4.0mm		50x4.0mm		100x4.0mm		150x4.0mm	250x4.0mm		
HS-0340-M085	\$235	HS-0540-M085	\$245	HS-1040-M085	\$255	HS-1540-M085	\$260	HS-2540-M085	\$270
30x3.0mm		50x3.0mm		100x3.0mm		150x3.0mm	250x3.0mm		
HS-0330-M085	\$235	HS-0530-M085	\$245	HS-1030-M085	\$255	HS-1530-M085	\$260	HS-2530-M085	\$270
30x2.1mm		50x2.1mm		100x2.1mm		150x2.1mm	250x2.1mm		
HS-0321-M085	\$235	HS-0521-M085	\$245	HS-1021-M085	\$255	HS-1521-M085	\$260	HS-2521-M085	\$270

HAISIL 100 C18 5µm		4.6, 4.0, 3.0, and 2.1mm I.D. s.s. columns							
30x4.6mm		50x4.6mm		100x4.6mm		150x4.6mm	250x4.6mm		
HS-0346-M185	\$235	HS-0546-M185	\$245	HS-1046-M185	\$255	HS-1546-M185	\$260	HS-2546-M185	\$270
30x4.0mm		50x4.0mm		100x4.0mm		150x4.0mm	250x4.0mm		
HS-0340-M185	\$235	HS-0540-M185	\$245	HS-1040-M185	\$255	HS-1540-M185	\$260	HS-2540-M185	\$270
30x3.0mm		50x3.0mm		100x3.0mm		150x3.0mm	250x3.0mm		
HS-0330-M185	\$235	HS-0530-M185	\$245	HS-1030-M185	\$255	HS-1530-M185	\$260	HS-2530-M185	\$270
30x2.1mm		50x2.1mm		100x2.1mm		150x2.1mm	250x2.1mm		
HS-0321-M185	\$235	HS-0521-M185	\$245	HS-1021-M185	\$255	HS-1521-M185	\$260	HS-2521-M185	\$270



HPLC Columns (continued)

Wide Range of Stainless Steel HPLC COLUMNS



HAISIL100 Analytical Columns - Stainless Steel (cont.)



HAISIL 100 Silica 5µm		4.6, 4.0, 3.0, and 2.1mm I.D. s.s. columns							
30x4.6mm		50x4.6mm		100x4.6mm		150x4.6mm		250x4.6mm	
HS-0346-SIL5	\$235	HS-0546-SIL5	\$245	HS-1046-SIL5	\$255	HS-1546-SIL5	\$260	HS-2546-SIL5	\$270
30x4.0mm		50x4.0mm		100x4.0mm		150x4.0mm		250x4.0mm	
HS-0340-SIL5	\$235	HS-0540-SIL5	\$245	HS-1040-SIL5	\$255	HS-1540-SIL5	\$260	HS-2540-SIL5	\$270
30x3.0mm		50x3.0mm		100x3.0mm		150x3.0mm		250x3.0mm	
HS-0330-SIL5	\$235	HS-0530-SIL5	\$245	HS-1030-SIL5	\$255	HS-1530-SIL5	\$260	HS-2530-SIL5	\$270
30x2.1mm		50x2.1mm		100x2.1mm		150x2.1mm		250x2.1mm	
HS-0321-SIL5	\$235	HS-0521-SIL5	\$245	HS-1021-SIL5	\$255	HS-1521-SIL5	\$260	HS-2521-SIL5	\$270

HAISIL300 Analytical Columns - Stainless Steel



HAISIL 300 C18 5µm		4.6, 4.0, 3.0, and 2.1mm I.D. s.s. columns							
30x4.6mm		50x4.6mm		100x4.6mm		150x4.6mm		250x4.6mm	
HS-0346-W185	\$310	HS-0546-W185	\$320	HS-1046-W185	\$350	HS-1546-W185	\$375	HS-2546-W185	\$405
30x4.0mm		50x4.0mm		100x4.0mm		150x4.0mm		250x4.0mm	
HS-0340-W185	\$310	HS-0540-W185	\$320	HS-1040-W185	\$350	HS-1540-W185	\$375	HS-2540-W185	\$405
30x3.0mm		50x3.0mm		100x3.0mm		150x3.0mm		250x3.0mm	
HS-0330-W185	\$310	HS-0530-W185	\$320	HS-1030-W185	\$350	HS-1530-W185	\$375	HS-2530-W185	\$405
30x2.1mm		50x2.1mm		100x2.1mm		150x2.1mm		250x2.1mm	
HS-0321-W185	\$310	HS-0521-W185	\$320	HS-1021-W185	\$350	HS-1521-W185	\$375	HS-2521-W185	\$405

HAISIL HL Analytical Columns - Stainless Steel



HAISIL HL C18 5µm		4.6, 4.0, 3.0, and 2.1mm I.D. s.s. columns							
30x4.6mm		50x4.6mm		100x4.6mm		150x4.6mm		250x4.6mm	
LS-0346-C185	\$380	LS-0546-C185	\$390	LS-1046-C185	\$400	LS-1546-C185	\$425	LS-2546-C185	\$440
30x4.0mm		50x4.0mm		100x4.0mm		150x4.0mm		250x4.0mm	
LS-0340-C185	\$380	LS-0540-C185	\$390	LS-1040-C185	\$400	LS-1540-C185	\$425	LS-2540-C185	\$440
30x3.0mm		50x3.0mm		100x3.0mm		150x3.0mm		250x3.0mm	
LS-0330-C185	\$380	LS-0530-C185	\$390	LS-1030-C185	\$400	LS-1530-C185	\$425	LS-2530-C185	\$440
30x2.1mm		50x2.1mm		100x2.1mm		150x2.1mm		250x2.1mm	
LS-0321-C185	\$380	LS-0521-C185	\$390	LS-1021-C185	\$400	LS-1521-C185	\$425	LS-2521-C185	\$440

HEAVY Analytical Columns - Stainless Steel



HEAVY C18 5µm		4.6, 4.0, 3.0, and 2.1mm I.D. s.s. columns							
30x4.6mm		50x4.6mm		100x4.6mm		150x4.6mm		250x4.6mm	
VS-0346-C185	\$310	VS-0546-C185	\$320	VS-1046-C185	\$350	VS-1546-C185	\$375	VS-2546-C185	\$405
30x4.0mm		50x4.0mm		100x4.0mm		150x4.0mm		250x4.0mm	
VS-0340-C185	\$310	VS-0540-C185	\$320	VS-1040-C185	\$350	VS-1540-C185	\$375	VS-2540-C185	\$405
30x3.0mm		50x3.0mm		100x3.0mm		150x3.0mm		250x3.0mm	
VS-0330-C185	\$310	VS-0530-C185	\$320	VS-1030-C185	\$350	VS-1530-C185	\$375	VS-2530-C185	\$405
30x2.1mm		50x2.1mm		100x2.1mm		150x2.1mm		250x2.1mm	
VS-0321-C185	\$310	VS-0521-C185	\$320	VS-1021-C185	\$350	VS-1521-C185	\$375	VS-2521-C185	\$405



PROTO 200 Analytical Columns - Stainless Steel

200

PROTO 200 C4 5µm		4.6, 4.0, 3.0, and 2.1mm I.D. s.s. columns							
30x4.6mm		50x4.6mm		100x4.6mm		150x4.6mm		250x4.6mm	
RS-0346-D045	\$310	RS-0546-D045	\$320	RS-1046-D045	\$350	RS-1546-D045	\$375	RS-2546-D045	\$405
30x4.0mm		50x4.0mm		100x4.0mm		150x4.0mm		250x4.0mm	
RS-0340-D045	\$310	RS-0540-D045	\$320	RS-1040-D045	\$350	RS-1540-D045	\$375	RS-2540-D045	\$405
30x3.0mm		50x3.0mm		100x3.0mm		150x3.0mm		250x3.0mm	
RS-0330-D045	\$310	RS-0530-D045	\$320	RS-1030-D045	\$350	RS-1530-D045	\$375	RS-2530-D045	\$405
30x2.1mm		50x2.1mm		100x2.1mm		150x2.1mm		250x2.1mm	
RS-0321-D045	\$310	RS-0521-D045	\$320	RS-1021-D045	\$350	RS-1521-D045	\$375	RS-2521-D045	\$405

PROTO 200 C18 5µm		4.6, 4.0, 3.0, and 2.1mm I.D. s.s. columns							
30x4.6mm		50x4.6mm		100x4.6mm		150x4.6mm		250x4.6mm	
RS-0346-D185	\$310	RS-0546-D185	\$320	RS-1046-D185	\$350	RS-1546-D185	\$375	RS-2546-D185	\$405
30x4.0mm		50x4.0mm		100x4.0mm		150x4.0mm		250x4.0mm	
RS-0340-D185	\$310	RS-0540-D185	\$320	RS-1040-D185	\$350	RS-1540-D185	\$375	RS-2540-D185	\$405
30x3.0mm		50x3.0mm		100x3.0mm		150x3.0mm		250x3.0mm	
RS-0330-D185	\$310	RS-0530-D185	\$320	RS-1030-D185	\$350	RS-1530-D185	\$375	RS-2530-D185	\$405
30x2.1mm		50x2.1mm		100x2.1mm		150x2.1mm		250x2.1mm	
RS-0321-D185	\$310	RS-0521-D185	\$320	RS-1021-D185	\$350	RS-1521-D185	\$375	RS-2521-D185	\$405

PROTO 300 Analytical Columns - Stainless Steel



PROTO 300 C4 5µm		4.6, 4.0, 3.0, and 2.1mm I.D. s.s. columns							
30x4.6mm		50x4.6mm		100x4.6mm		150x4.6mm		250x4.6mm	
RS-0346-W045	\$310	RS-0546-W045	\$320	RS-1046-W045	\$350	RS-1546-W045	\$375	RS-2546-W045	\$405
30x4.0mm		50x4.0mm		100x4.0mm		150x4.0mm		250x4.0mm	
RS-0340-W045	\$310	RS-0540-W045	\$320	RS-1040-W045	\$350	RS-1540-W045	\$375	RS-2540-W045	\$405
30x3.0mm		50x3.0mm		100x3.0mm		150x3.0mm		250x3.0mm	
RS-0330-W045	\$310	RS-0530-W045	\$320	RS-1030-W045	\$350	RS-1530-W045	\$375	RS-2530-W045	\$405
30x2.1mm		50x2.1mm		100x2.1mm		150x2.1mm		250x2.1mm	
RS-0321-W045	\$310	RS-0521-W045	\$320	RS-1021-W045	\$350	RS-1521-W045	\$375	RS-2521-W045	\$405

PROTO 300 C18 5µm		4.6, 4.0, 3.0, and 2.1mm I.D. s.s. columns							
30x4.6mm		50x4.6mm		100x4.6mm		150x4.6mm		250x4.6mm	
RS-0346-W185	\$310	RS-0546-W185	\$320	RS-1046-W185	\$350	RS-1546-W185	\$375	RS-2546-W185	\$405
30x4.0mm		50x4.0mm		100x4.0mm		150x4.0mm		250x4.0mm	
RS-0340-W185	\$310	RS-0540-W185	\$320	RS-1040-W185	\$350	RS-1540-W185	\$375	RS-2540-W185	\$405
30x3.0mm		50x3.0mm		100x3.0mm		150x3.0mm		250x3.0mm	
RS-0330-W185	\$310	RS-0530-W185	\$320	RS-1030-W185	\$350	RS-1530-W185	\$375	RS-2530-W185	\$405
30x2.1mm		50x2.1mm		100x2.1mm		150x2.1mm		250x2.1mm	
RS-0321-W185	\$310	RS-0521-W185	\$320	RS-1021-W185	\$350	RS-1521-W185	\$375	RS-2521-W185	\$405



HPLC Columns (continued)

Wide Range of Stainless Steel HPLC COLUMNS



NEW 3µm

PHALANX Analytical Columns - Stainless Steel

PHALANX C18 3µm		4.6, 4.0, 3.0, and 2.1mm I.D. s.s. columns							
30x4.6mm		50x4.6mm		100x4.6mm		150x4.6mm		250x4.6mm	
PS-0346-C183	\$380	PS-0546-C183	\$390	PS-1046-C183	\$440	PS-1546-C183	\$475	PS-2546-C183	\$500
30x4.0mm		50x4.0mm		100x4.0mm		150x4.0mm		250x4.0mm	
PS-0340-C183	\$380	PS-0540-C183	\$390	PS-1040-C183	\$440	PS-1540-C183	\$475	PS-2540-C183	\$500
30x3.0mm		50x3.0mm		100x3.0mm		150x3.0mm		250x3.0mm	
PS-0330-C183	\$380	PS-0530-C183	\$390	PS-1030-C183	\$440	PS-1530-C183	\$475	PS-2530-C183	\$500
30x2.1mm		50x2.1mm		100x2.1mm		150x2.1mm		250x2.1mm	
PS-0321-C183	\$380	PS-0521-C183	\$390	PS-1021-C183	\$440	PS-1521-C183	\$475	PS-2521-C183	\$500

PHALANX C18 5µm		4.6, 4.0, 3.0, and 2.1mm I.D. s.s. columns							
30x4.6mm		50x4.6mm		100x4.6mm		150x4.6mm		250x4.6mm	
PS-0346-C185	\$310	PS-0546-C185	\$320	PS-1046-C185	\$350	PS-1546-C185	\$375	PS-2546-C185	\$405
30x4.0mm		50x4.0mm		100x4.0mm		150x4.0mm		250x4.0mm	
PS-0340-C185	\$310	PS-0540-C185	\$320	PS-1040-C185	\$350	PS-1540-C185	\$375	PS-2540-C185	\$405
30x3.0mm		50x3.0mm		100x3.0mm		150x3.0mm		250x3.0mm	
PS-0330-C185	\$310	PS-0530-C185	\$320	PS-1030-C185	\$350	PS-1530-C185	\$375	PS-2530-C185	\$405
30x2.1mm		50x2.1mm		100x2.1mm		150x2.1mm		250x2.1mm	
PS-0321-C185	\$310	PS-0521-C185	\$320	PS-1021-C185	\$350	PS-1521-C185	\$375	PS-2521-C185	\$405

Comparison of PHALANX to Kromasil C18 for a Pharmaceutical Drug Analysis 150 X 4.6mm Columns, 1mL/min Linear Gradient for 50 minutes

PHALANX Full Scale Chromatogram

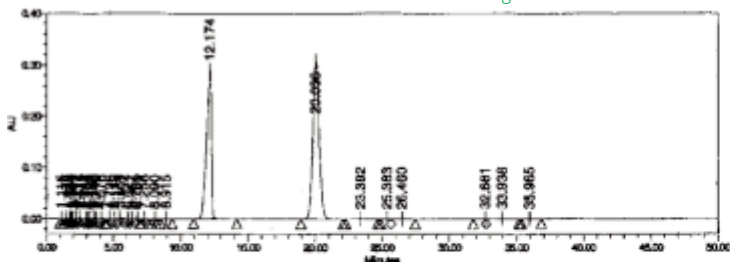

KROMASIL C18 Full Scale Chromatogram

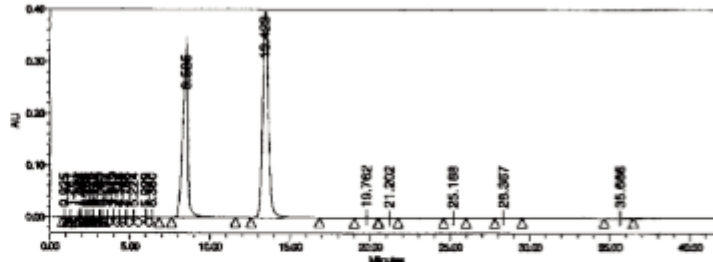

PHALANX Expanded Scale Chromatogram

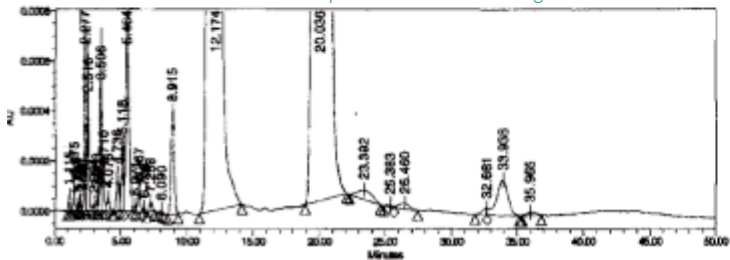

KROMASIL C18 Expanded Scale Chromatogram

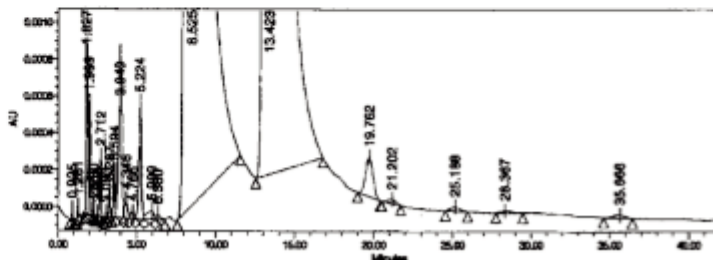

Higgins Analytical thanks Amos Heckendorf of The Nest Group (www.nestgrp.com) for these data.

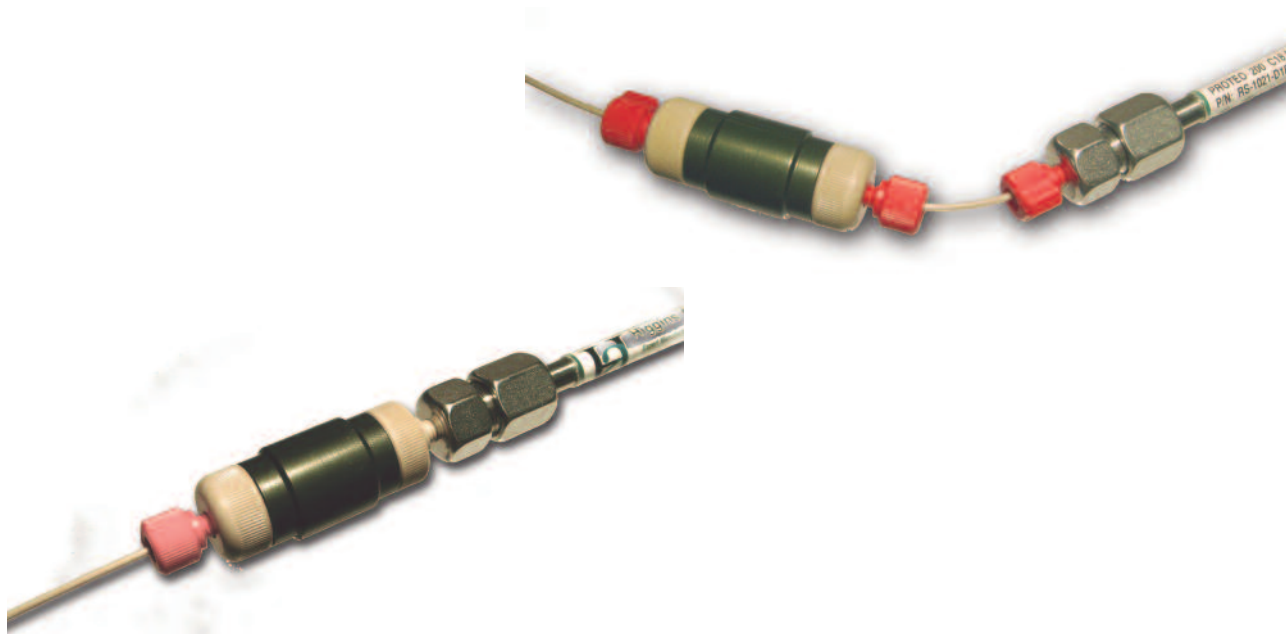

See pages 60 - 63 for information on the wide variety of Guard Cartridges available for these Analytical Columns

TARGA Analytical Columns - Stainless Steel



TARGA C8 5µm		4.6, 4.0, 3.0, and 2.1mm I.D. s.s. columns							
30x4.6mm		50x4.6mm		100x4.6mm		150x4.6mm		250x4.6mm	
TS-0346-C085	\$290	TS-0546-C085	\$300	TS-1046-C085	\$320	TS-1546-C085	\$350	TS-2546-C085	\$370
30x4.0mm		50x4.0mm		100x4.0mm		150x4.0mm		250x4.0mm	
TS-0340-C085	\$290	TS-0540-C085	\$300	TS-1040-C085	\$320	TS-1540-C085	\$350	TS-2540-C085	\$370
30x3.0mm		50x3.0mm		100x3.0mm		150x3.0mm		250x3.0mm	
TS-0330-C085	\$290	TS-0530-C085	\$300	TS-1030-C085	\$320	TS-1530-C085	\$350	TS-2530-C085	\$370
30x2.1mm		50x2.1mm		100x2.1mm		150x2.1mm		250x2.1mm	
TS-0321-C085	\$290	TS-0521-C085	\$300	TS-1021-C085	\$320	TS-1521-C085	\$350	TS-2521-C085	\$370

TARGA C18 3µm		4.6, 4.0, 3.0, and 2.1mm I.D. s.s. columns							
30x4.6mm		50x4.6mm		100x4.6mm		150x4.6mm		250x4.6mm	
TS-0346-C183	\$365	TS-0546-C183	\$375	TS-1046-C183	\$400	TS-1546-C183	\$430	TS-2546-C183	\$455
30x4.0mm		50x4.0mm		100x4.0mm		150x4.0mm		250x4.0mm	
TS-0340-C183	\$365	TS-0540-C183	\$375	TS-1040-C183	\$400	TS-1540-C183	\$430	TS-2540-C183	\$455
30x3.0mm		50x3.0mm		100x3.0mm		150x3.0mm		250x3.0mm	
TS-0330-C183	\$365	TS-0530-C183	\$375	TS-1030-C183	\$400	TS-1530-C183	\$430	TS-2530-C183	\$455
30x2.1mm		50x2.1mm		100x2.1mm		150x2.1mm		250x2.1mm	
TS-0321-C183	\$365	TS-0521-C183	\$375	TS-1021-C183	\$400	TS-1521-C183	\$430	TS-2521-C183	\$455

TARGA C18 5µm		4.6, 4.0, 3.0, and 2.1mm I.D. s.s. columns							
30x4.6mm		50x4.6mm		100x4.6mm		150x4.6mm		250x4.6mm	
TS-0346-C185	\$290	TS-0546-C185	\$300	TS-1046-C185	\$320	TS-1546-C185	\$350	TS-2546-C185	\$370
30x4.0mm		50x4.0mm		100x4.0mm		150x4.0mm		250x4.0mm	
TS-0340-C185	\$290	TS-0540-C185	\$300	TS-1040-C185	\$320	TS-1540-C185	\$350	TS-2540-C185	\$370
30x3.0mm		50x3.0mm		100x3.0mm		150x3.0mm		250x3.0mm	
TS-0330-C185	\$290	TS-0530-C185	\$300	TS-1030-C185	\$320	TS-1530-C185	\$350	TS-2530-C185	\$370
30x2.1mm		50x2.1mm		100x2.1mm		150x2.1mm		250x2.1mm	
TS-0321-C185	\$290	TS-0521-C185	\$300	TS-1021-C185	\$320	TS-1521-C185	\$350	TS-2521-C185	\$370



Microbore HPLC Columns

Wide Range of 1mm, 0.8mm, 0.5mm, and 0.3mm Columns



Widest Range of Microbore column sizes with a wide range of sorbents

Higgins Analytical manufactures the widest range of Microbore column formats available anywhere. In addition to the glass-lined columns ranging from 300µm to 1mm I.D., we also provide unique PEEK/Titanium microbore columns for specialized applications (see Piccolo).

Guide to MICROBORE Part Numbers

- xS-xx01-xxxx 1.0mm Microbore
- xS-xxM8-xxxx 0.8mm Microbore
- xS-xxM5-xxxx 0.5mm Microbore
- xS-xxM3-xxxx 0.3mm Microbore

See Page 23 for complete Part Number information

CLIQUEUS Microbore Columns



CLIQUEUS C8 5µm		1.0, 0.8, 0.5, and 0.3mm I.D. s.s. columns							
30x1.0mm		50x1.0mm		100x1.0mm		150x1.0mm		250x1.0mm	
CS-0301-C085	\$310	CS-0501-C085	\$320	CS-1001-C085	\$350	CS-1501-C085	\$375	CS-2501-C085	\$405
30x0.8mm		50x0.8mm		100x0.8mm		150x0.8mm		250x0.8mm	
CS-03M8-C085	\$310	CS-05M8-C085	\$320	CS-10M8-C085	\$350	CS-15M8-C085	\$375	CS-25M8-C085	\$405
30x0.5mm		50x0.5mm		100x0.5mm		150x0.5mm		250x0.5mm	
CS-03M5-C085	\$310	CS-05M5-C085	\$320	CS-10M5-C085	\$350	CS-15M5-C085	\$375	CS-25M5-C085	\$405
30x0.3mm		50x0.3mm		100x0.3mm		150x0.3mm		250x0.3mm	
CS-03M3-C085	\$310	CS-05M3-C085	\$320	CS-10M3-C085	\$350	CS-15M3-C085	\$375	CS-25M3-C085	\$405

CLIQUEUS C18 5µm		1.0, 0.8, 0.5, and 0.3mm I.D. s.s. columns							
30x1.0mm		50x1.0mm		100x1.0mm		150x1.0mm		250x1.0mm	
CS-0301-C185	\$310	CS-0501-C185	\$320	CS-1001-C185	\$350	CS-1501-C185	\$375	CS-2501-C185	\$405
30x0.8mm		50x0.8mm		100x0.8mm		150x0.8mm		250x0.8mm	
CS-03M8-C185	\$310	CS-05M8-C185	\$320	CS-10M8-C185	\$350	CS-15M8-C185	\$375	CS-25M8-C185	\$405
30x0.5mm		50x0.5mm		100x0.5mm		150x0.5mm		250x0.5mm	
CS-03M5-C185	\$310	CS-05M5-C185	\$320	CS-10M5-C185	\$350	CS-15M5-C185	\$375	CS-25M5-C185	\$405
30x0.3mm		50x0.3mm		100x0.3mm		150x0.3mm		250x0.3mm	
CS-03M3-C185	\$310	CS-05M3-C185	\$320	CS-10M3-C185	\$350	CS-15M3-C185	\$375	CS-25M3-C185	\$405

CLIQUEUS Cyano 5µm		1.0, 0.8, 0.5, and 0.3mm I.D. s.s. columns							
30x1.0mm		50x1.0mm		100x1.0mm		150x1.0mm		250x1.0mm	
CS-0301-CNP5	\$325	CS-0501-CNP5	\$340	CS-1001-CNP5	\$365	CS-1501-CNP5	\$390	CS-2501-CNP5	\$425
30x0.8mm		50x0.8mm		100x0.8mm		150x0.8mm		250x0.8mm	
CS-03M8-CNP5	\$325	CS-05M8-CNP5	\$340	CS-10M8-CNP5	\$365	CS-15M8-CNP5	\$390	CS-25M8-CNP5	\$425
30x0.5mm		50x0.5mm		100x0.5mm		150x0.5mm		250x0.5mm	
CS-03M5-CNP5	\$325	CS-05M5-CNP5	\$340	CS-10M5-CNP5	\$365	CS-15M5-CNP5	\$390	CS-25M5-CNP5	\$425
30x0.3mm		50x0.3mm		100x0.3mm		150x0.3mm		250x0.3mm	
CS-03M3-CNP5	\$325	CS-05M3-CNP5	\$340	CS-10M3-CNP5	\$365	CS-15M3-CNP5	\$390	CS-25M3-CNP5	\$425

CLIQUEUS Phenyl 5µm		1.0, 0.8, 0.5, and 0.3mm I.D. s.s. columns							
30x1.0mm		50x1.0mm		100x1.0mm		150x1.0mm		250x1.0mm	
CS-0301-PHN5	\$325	CS-0501-PHN5	\$340	CS-1001-PHN5	\$365	CS-1501-PHN5	\$390	CS-2501-PHN5	\$425
30x0.8mm		50x0.8mm		100x0.8mm		150x0.8mm		250x0.8mm	
CS-03M8-PHN5	\$325	CS-05M8-PHN5	\$340	CS-10M8-PHN5	\$365	CS-15M8-PHN5	\$390	CS-25M8-PHN5	\$425
30x0.5mm		50x0.5mm		100x0.5mm		150x0.5mm		250x0.5mm	
CS-03M5-PHN5	\$325	CS-05M5-PHN5	\$340	CS-10M5-PHN5	\$365	CS-15M5-PHN5	\$390	CS-25M5-PHN5	\$425
30x0.3mm		50x0.3mm		100x0.3mm		150x0.3mm		250x0.3mm	
CS-03M3-PHN5	\$325	CS-05M3-PHN5	\$340	CS-10M3-PHN5	\$365	CS-15M3-PHN5	\$390	CS-25M3-PHN5	\$425



CLYPEUS Microbore Columns (cont.)



CLYPEUS Silica 5µm		1.0, 0.8, 0.5, and 0.3mm I.D. s.s. columns							
30x1.0mm		50x1.0mm		100x1.0mm		150x1.0mm		250x1.0mm	
CS-0301-SIL5	\$310	CS-0501-SIL5	\$320	CS-1001-SIL5	\$350	CS-1501-SIL5	\$375	CS-2501-SIL5	\$405
30x0.8mm		50x0.8mm		100x0.8mm		150x0.8mm		250x0.8mm	
CS-03M8-SIL5	\$310	CS-05M8-SIL5	\$320	CS-10M8-SIL5	\$350	CS-15M8-SIL5	\$375	CS-25M8-SIL5	\$405
30x0.5mm		50x0.5mm		100x0.5mm		150x0.5mm		250x0.5mm	
CS-03M5-SIL5	\$310	CS-05M5-SIL5	\$320	CS-10M5-SIL5	\$350	CS-15M5-SIL5	\$375	CS-25M5-SIL5	\$405
30x0.3mm		50x0.3mm		100x0.3mm		150x0.3mm		250x0.3mm	
CS-03M3-SIL5	\$310	CS-05M3-SIL5	\$320	CS-10M3-SIL5	\$350	CS-15M3-SIL5	\$375	CS-25M3-SIL5	\$405

HAISIL100 Microbore Columns



HAISIL 100 C8 5µm		1.0, 0.8, 0.5, and 0.3mm I.D. s.s. columns							
30x1.0mm		50x1.0mm		100x1.0mm		150x1.0mm		250x1.0mm	
HS-0301-M085	\$270	HS-0501-M085	\$280	HS-1001-M085	\$295	HS-1501-M085	\$320	HS-2501-M085	\$350
30x0.8mm		50x0.8mm		100x0.8mm		150x0.8mm		250x0.8mm	
HS-03M8-M085	\$270	HS-05M8-M085	\$280	HS-10M8-M085	\$295	HS-15M8-M085	\$320	HS-25M8-M085	\$350
30x0.5mm		50x0.5mm		100x0.5mm		150x0.5mm		250x0.5mm	
HS-03M5-M085	\$270	HS-05M5-M085	\$280	HS-10M5-M085	\$295	HS-15M5-M085	\$320	HS-25M5-M085	\$350
30x0.3mm		50x0.3mm		100x0.3mm		150x0.3mm		250x0.3mm	
HS-03M3-M085	\$270	HS-05M3-M085	\$280	HS-10M3-M085	\$295	HS-15M3-M085	\$320	HS-25M3-M085	\$350

HAISIL 100 C18 5µm		1.0, 0.8, 0.5, and 0.3mm I.D. s.s. columns							
30x1.0mm		50x1.0mm		100x1.0mm		150x1.0mm		250x1.0mm	
HS-0301-M185	\$270	HS-0501-M185	\$280	HS-1001-M185	\$295	HS-1501-M185	\$320	HS-2501-M185	\$350
30x0.8mm		50x0.8mm		100x0.8mm		150x0.8mm		250x0.8mm	
HS-03M8-M185	\$270	HS-05M8-M185	\$280	HS-10M8-M185	\$295	HS-15M8-M185	\$320	HS-25M8-M185	\$350
30x0.5mm		50x0.5mm		100x0.5mm		150x0.5mm		250x0.5mm	
HS-03M5-M185	\$270	HS-05M5-M185	\$280	HS-10M5-M185	\$295	HS-15M5-M185	\$320	HS-25M5-M185	\$350
30x0.3mm		50x0.3mm		100x0.3mm		150x0.3mm		250x0.3mm	
HS-03M3-M185	\$270	HS-05M3-M185	\$280	HS-10M3-M185	\$295	HS-15M3-M185	\$320	HS-25M3-M185	\$350

HAISIL 100 Silica 5µm		1.0, 0.8, 0.5, and 0.3mm I.D. s.s. columns							
30x1.0mm		50x1.0mm		100x1.0mm		150x1.0mm		250x1.0mm	
HS-0301-SIL5	\$270	HS-0501-SIL5	\$280	HS-1001-SIL5	\$295	HS-1501-SIL5	\$320	HS-2501-SIL5	\$350
30x0.8mm		50x0.8mm		100x0.8mm		150x0.8mm		250x0.8mm	
HS-03M8-SIL5	\$270	HS-05M8-SIL5	\$280	HS-10M8-SIL5	\$295	HS-15M8-SIL5	\$320	HS-25M8-SIL5	\$350
30x0.5mm		50x0.5mm		100x0.5mm		150x0.5mm		250x0.5mm	
HS-03M5-SIL5	\$270	HS-05M5-SIL5	\$280	HS-10M5-SIL5	\$295	HS-15M5-SIL5	\$320	HS-25M5-SIL5	\$350
30x0.3mm		50x0.3mm		100x0.3mm		150x0.3mm		250x0.3mm	
HS-03M3-SIL5	\$270	HS-05M3-SIL5	\$280	HS-10M3-SIL5	\$295	HS-15M3-SIL5	\$320	HS-25M3-SIL5	\$350



Microbore HPLC Columns (continued)

Wide Range of 1mm, 0.5mm, and 0.3mm Columns



HAISIL300 Microbore Columns



HAISIL 300 C18 5µm		1.0, 0.8, 0.5, and 0.3mm I.D. s.s. columns							
30x1.0mm		50x1.0mm		100x1.0mm		150x1.0mm		250x1.0mm	
HS-0301-W185	\$320	HS-0501-W185	\$330	HS-1001-W185	\$350	HS-1501-W185	\$375	HS-2501-W185	\$400
30x0.8mm		50x0.8mm		100x0.8mm		150x0.8mm		250x0.8mm	
HS-03M8-W185	\$320	HS-05M8-W185	\$330	HS-10M8-W185	\$350	HS-15M8-W185	\$375	HS-25M8-W185	\$400
30x0.5mm		50x0.5mm		100x0.5mm		150x0.5mm		250x0.5mm	
HS-03M5-W185	\$320	HS-05M5-W185	\$330	HS-10M5-W185	\$350	HS-15M5-W185	\$375	HS-25M5-W185	\$400
30x0.3mm		50x0.3mm		100x0.3mm		150x0.3mm		250x0.3mm	
HS-03M3-W185	\$320	HS-05M3-W185	\$330	HS-10M3-W185	\$350	HS-15M3-W185	\$375	HS-25M3-W185	\$400

HAISIL HL Microbore Columns



HAISIL HL C18 5µm		1.0, 0.8, 0.5, and 0.3mm I.D. s.s. columns							
30x1.0mm		50x1.0mm		100x1.0mm		150x1.0mm		250x1.0mm	
LS-0301-C185	\$320	LS-0501-C185	\$330	LS-1001-C185	\$350	LS-1501-C185	\$375	LS-2501-C185	\$400
30x0.8mm		50x0.8mm		100x0.8mm		150x0.8mm		250x0.8mm	
LS-03M8-C185	\$320	LS-05M8-C185	\$330	LS-10M8-C185	\$350	LS-15M8-C185	\$375	LS-25M8-C185	\$400
30x0.5mm		50x0.5mm		100x0.5mm		150x0.5mm		250x0.5mm	
LS-03M5-C185	\$320	LS-05M5-C185	\$330	LS-10M5-C185	\$350	LS-15M5-C185	\$375	LS-25M5-C185	\$400
30x0.3mm		50x0.3mm		100x0.3mm		150x0.3mm		250x0.3mm	
LS-03M3-C185	\$320	LS-05M3-C185	\$330	LS-10M3-C185	\$350	LS-15M3-C185	\$375	LS-25M3-C185	\$400

HEAVY Microbore Columns



HEAVY C18 5µm		1.0, 0.8, 0.5, and 0.3mm I.D. s.s. columns							
30x1.0mm		50x1.0mm		100x1.0mm		150x1.0mm		250x1.0mm	
VS-0301-C185	\$320	VS-0501-C185	\$330	VS-1001-C185	\$350	VS-1501-C185	\$375	VS-2501-C185	\$400
30x0.8mm		50x0.8mm		100x0.8mm		150x0.8mm		250x0.8mm	
VS-03M8-C185	\$320	VS-05M8-C185	\$330	VS-10M8-C185	\$350	VS-15M8-C185	\$375	VS-25M8-C185	\$400
30x0.5mm		50x0.5mm		100x0.5mm		150x0.5mm		250x0.5mm	
VS-03M5-C185	\$320	VS-05M5-C185	\$330	VS-10M5-C185	\$350	VS-15M5-C185	\$375	VS-25M5-C185	\$400
30x0.3mm		50x0.3mm		100x0.3mm		150x0.3mm		250x0.3mm	
VS-03M3-C185	\$320	VS-05M3-C185	\$330	VS-10M3-C185	\$350	VS-15M3-C185	\$375	VS-25M3-C185	\$400



PROTO 200 Microbore Columns

200

PROTO 200 C4 5µm		1.0, 0.8, 0.5, and 0.3mm I.D. s.s. columns					
30x1.0mm		50x1.0mm		100x1.0mm		150x1.0mm	250x1.0mm
RS-0301-D045	\$320	RS-0501-D045	\$330	RS-1001-D045	\$350	RS-1501-D045	RS-2501-D045
30x0.8mm		50x0.8mm		100x0.8mm		150x0.8mm	250x0.8mm
RS-03M8-D185	\$320	RS-05M8-D185	\$330	RS-10M8-D185	\$350	RS-15M8-D185	RS-25M8-D185
30x0.5mm		50x0.5mm		100x0.5mm		150x0.5mm	250x0.5mm
RS-03M5-D045	\$320	RS-05M5-D045	\$330	RS-10M5-D045	\$350	RS-15M5-D045	RS-25M5-D045
30x0.3mm		50x0.3mm		100x0.3mm		150x0.3mm	250x0.3mm
RS-03M3-D045	\$320	RS-05M3-D045	\$330	RS-10M3-D045	\$350	RS-15M3-D045	RS-25M3-D045

PROTO 200 C18 5µm		1.0, 0.8, 0.5, and 0.3mm I.D. s.s. columns					
30x1.0mm		50x1.0mm		100x1.0mm		150x1.0mm	250x1.0mm
RS-0301-D185	\$320	RS-0501-D185	\$330	RS-1001-D185	\$350	RS-1501-D185	RS-2501-D185
30x0.8mm		50x0.8mm		100x0.8mm		150x0.8mm	250x0.8mm
RS-03M8-D185	\$320	RS-05M8-D185	\$330	RS-10M8-D185	\$350	RS-15M8-D185	RS-25M8-D185
30x0.5mm		50x0.5mm		100x0.5mm		150x0.5mm	250x0.5mm
RS-03M5-D185	\$320	RS-05M5-D185	\$330	RS-10M5-D185	\$350	RS-15M5-D185	RS-25M5-D185
30x0.3mm		50x0.3mm		100x0.3mm		150x0.3mm	250x0.3mm
RS-03M3-D185	\$320	RS-05M3-D185	\$330	RS-10M3-D185	\$350	RS-15M3-D185	RS-25M3-D185

PROTO 300 Microbore Columns



PROTO 300 C4 5µm		1.0, 0.8, 0.5, and 0.3mm I.D. s.s. columns					
30x1.0mm		50x1.0mm		100x1.0mm		150x1.0mm	250x1.0mm
RS-0301-W045	\$320	RS-0501-W045	\$330	RS-1001-W045	\$350	RS-1501-W045	RS-2501-W045
30x0.8mm		50x0.8mm		100x0.8mm		150x0.8mm	250x0.8mm
RS-03M8-W045	\$320	RS-05M8-W045	\$330	RS-10M8-W045	\$350	RS-15M8-W045	RS-25M8-W045
30x0.5mm		50x0.5mm		100x0.5mm		150x0.5mm	250x0.5mm
RS-03M5-W045	\$320	RS-05M5-W045	\$330	RS-10M5-W045	\$350	RS-15M5-W045	RS-25M5-W045
30x0.3mm		50x0.3mm		100x0.3mm		150x0.3mm	250x0.3mm
RS-03M3-W045	\$320	RS-05M3-W045	\$330	RS-10M3-W045	\$350	RS-15M3-W045	RS-25M3-W045

PROTO 300 C18 5µm		1.0, 0.8, 0.5, and 0.3mm I.D. s.s. columns					
30x1.0mm		50x1.0mm		100x1.0mm		150x1.0mm	250x1.0mm
RS-0301-W185	\$320	RS-0501-W185	\$330	RS-1001-W185	\$350	RS-1501-W185	RS-2501-W185
30x0.8mm		50x0.8mm		100x0.8mm		150x0.8mm	250x0.8mm
RS-03M8-W185	\$320	RS-05M8-W185	\$330	RS-10M8-W185	\$350	RS-15M8-W185	RS-25M8-W185
30x0.5mm		50x0.5mm		100x0.5mm		150x0.5mm	250x0.5mm
RS-03M5-W185	\$320	RS-05M5-W185	\$330	RS-10M5-W185	\$350	RS-15M5-W185	RS-25M5-W185
30x0.3mm		50x0.3mm		100x0.3mm		150x0.3mm	250x0.3mm
RS-03M3-W185	\$320	RS-05M3-W185	\$330	RS-10M3-W185	\$350	RS-15M3-W185	RS-25M3-W185

PHALANX Microbore Columns (5µm PHALANX on following page)



NEW 3µm

PHALANX C18 3µm		1.0, 0.8, 0.5, and 0.3mm I.D. s.s. columns					
30x1.0mm		50x1.0mm		100x1.0mm		150x1.0mm	250x1.0mm
PS-0301-C183	\$380	PS-0501-C183	\$390	PS-1001-C183	\$440	PS-1501-C183	PS-2501-C183
30x0.8mm		50x0.8mm		100x0.8mm		150x0.8mm	250x0.8mm
PS-03M8-C183	\$380	PS-05M8-C183	\$390	PS-10M8-C183	\$440	PS-15M8-C183	PS-25M8-C183
30x0.5mm		50x0.5mm		100x0.5mm		150x0.5mm	250x0.5mm
PS-03M5-C183	\$380	PS-05M5-C183	\$390	PS-10M5-C183	\$440	PS-15M5-C183	PS-25M5-C183
30x0.3mm		50x0.3mm		100x0.3mm		150x0.3mm	250x0.3mm
PS-03M3-C183	\$380	PS-05M3-C183	\$390	PS-10M3-C183	\$440	PS-15M3-C183	PS-25M3-C183



Microbore HPLC Columns (continued)

Wide Range of 1mm, 0.5mm, and 0.3mm Columns



Higgins Analytical manufactures the widest range of Microbore HPLC Columns in the world.

PHALANX Microbore Columns (cont. - 3µm PHALANX on previous page)



PHALANX C18 5µm		1.0, 0.8, 0.5, and 0.3mm I.D. s.s. columns							
30x1.0mm		50x1.0mm		100x1.0mm		150x1.0mm		250x1.0mm	
PS-0301-C185	\$320	PS-0501-C185	\$330	PS-1001-C185	\$350	PS-1501-C185	\$375	PS-2501-C185	\$400
30x0.8mm		50x0.8mm		100x0.8mm		150x0.8mm		250x0.8mm	
PS-03M8-C185	\$320	PS-05M8-C185	\$330	PS-10M8-C185	\$350	PS-15M8-C185	\$375	PS-25M8-C185	\$400
30x0.5mm		50x0.5mm		100x0.5mm		150x0.5mm		250x0.5mm	
PS-03M5-C185	\$320	PS-05M5-C185	\$330	PS-10M5-C185	\$350	PS-15M5-C185	\$375	PS-25M5-C185	\$400
30x0.3mm		50x0.3mm		100x0.3mm		150x0.3mm		250x0.3mm	
PS-03M3-C185	\$320	PS-05M3-C185	\$330	PS-10M3-C185	\$350	PS-15M3-C185	\$375	PS-25M3-C185	\$400

TARGA Microbore Columns



TARGA C8 5µm		1.0, 0.8, 0.5, and 0.3mm I.D. s.s. columns							
30x1.0mm		50x1.0mm		100x1.0mm		150x1.0mm		250x1.0mm	
TS-0301-C085	\$320	TS-0501-C085	\$330	TS-1001-C085	\$350	TS-1501-C085	\$375	TS-2501-C085	\$400
30x0.8mm		50x0.8mm		100x0.8mm		150x0.8mm		250x0.8mm	
TS-03M8-C085	\$320	TS-05M8-C085	\$330	TS-10M8-C085	\$350	TS-15M8-C085	\$375	TS-25M8-C085	\$400
30x0.5mm		50x0.5mm		100x0.5mm		150x0.5mm		250x0.5mm	
TS-03M5-C085	\$320	TS-05M5-C085	\$330	TS-10M5-C085	\$350	TS-15M5-C085	\$375	TS-25M5-C085	\$400
30x0.3mm		50x0.3mm		100x0.3mm		150x0.3mm		250x0.3mm	
TS-03M3-C085	\$320	TS-05M3-C085	\$330	TS-10M3-C085	\$350	TS-15M3-C085	\$375	TS-25M3-C085	\$400

TARGA C18 3µm		1.0, 0.8, 0.5, and 0.3mm I.D. s.s. columns							
30x1.0mm		50x1.0mm		100x1.0mm		150x1.0mm		250x1.0mm	
TS-0301-C183	\$370	TS-0501-C183	\$380	TS-1001-C183	\$400	TS-1501-C183	\$430	TS-2501-C183	\$455
30x0.8mm		50x0.8mm		100x0.8mm		150x0.8mm		250x0.8mm	
TS-03M8-C183	\$370	TS-05M8-C183	\$380	TS-10M8-C183	\$400	TS-15M8-C183	\$430	TS-25M8-C183	\$455
30x0.5mm		50x0.5mm		100x0.5mm		150x0.5mm		250x0.5mm	
TS-03M5-C183	\$370	TS-05M5-C183	\$380	TS-10M5-C183	\$400	TS-15M5-C183	\$430	TS-25M5-C183	\$455
30x0.3mm		50x0.3mm		100x0.3mm		150x0.3mm		250x0.3mm	
TS-03M3-C183	\$370	TS-05M3-C183	\$380	TS-10M3-C183	\$400	TS-15M3-C183	\$430	TS-25M3-C183	\$455

TARGA C18 5µm		1.0, 0.8, 0.5, and 0.3mm I.D. s.s. columns							
30x1.0mm		50x1.0mm		100x1.0mm		150x1.0mm		250x1.0mm	
TS-0301-C185	\$320	TS-0501-C185	\$330	TS-1001-C185	\$350	TS-1501-C185	\$375	TS-2501-C185	\$400
30x0.8mm		50x0.8mm		100x0.8mm		150x0.8mm		250x0.8mm	
TS-03M8-C185	\$320	TS-05M8-C185	\$330	TS-10M8-C185	\$350	TS-15M8-C185	\$375	TS-25M8-C185	\$400
30x0.5mm		50x0.5mm		100x0.5mm		150x0.5mm		250x0.5mm	
TS-03M5-C185	\$320	TS-05M5-C185	\$330	TS-10M5-C185	\$350	TS-15M5-C185	\$375	TS-25M5-C185	\$400
30x0.3mm		50x0.3mm		100x0.3mm		150x0.3mm		250x0.3mm	
TS-03M3-C185	\$320	TS-05M3-C185	\$330	TS-10M3-C185	\$350	TS-15M3-C185	\$375	TS-25M3-C185	\$400



Comparison of a Higgins to Another Manufacturer's Imm Column

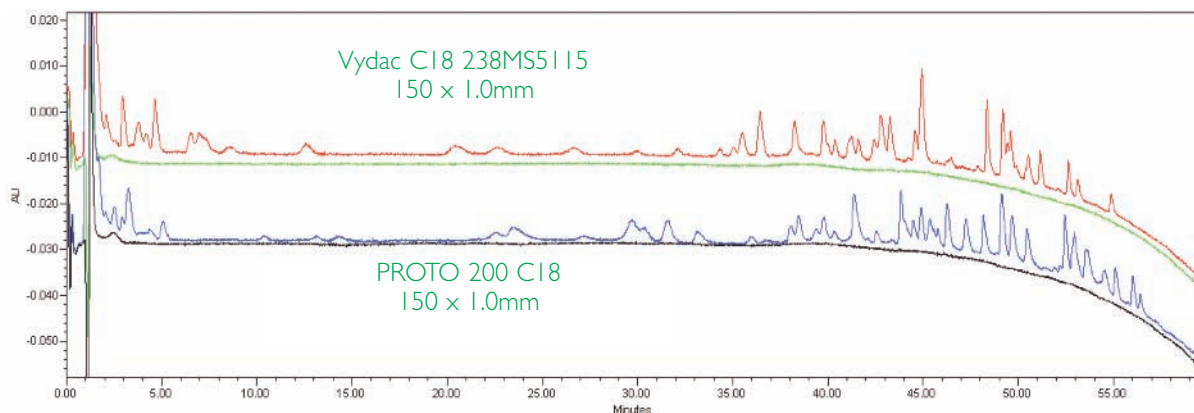

Tryptic Digest of Carbamidomethylated BSA (see page 15 for details)

POLYMERIC Reverse Phase Microbore Columns

POLYMERIC PLRP-S 100Å 3µm

30x1.0mm	50x1.0mm	100x1.0mm	150x1.0mm	250x1.0mm
PLS-0301-RP13 \$375	PLS-0501-RP13 \$385	PLS-1001-RP13 \$420	PLS-1501-RP13 \$450	PLS-2501-RP13 \$490
30x0.8mm	50x0.8mm	100x0.8mm	150x0.8mm	250x0.8mm
PLS-03M8-RP13 \$375	PLS-05M8-RP13 \$385	PLS-10M8-RP13 \$420	PLS-15M8-RP13 \$450	PLS-25M8-RP13 \$490
30x0.5mm	50x0.5mm	100x0.5mm	150x0.5mm	250x0.5mm
PLS-03M5-RP13 \$375	PLS-05M5-RP13 \$385	PLS-10M5-RP13 \$420	PLS-15M5-RP13 \$450	PLS-25M5-RP13 \$490
30x0.3mm	50x0.3mm	100x0.3mm	150x0.3mm	250x0.3mm
PLS-03M3-RP13 \$375	PLS-05M3-RP13 \$385	PLS-10M3-RP13 \$420	PLS-15M3-RP13 \$450	PLS-25M3-RP13 \$490

POLYMERIC PLRP-S 300Å 3µm

30x1.0mm	50x1.0mm	100x1.0mm	150x1.0mm	250x1.0mm
PLS-0301-RP33 \$375	PLS-0501-RP33 \$385	PLS-1001-RP33 \$420	PLS-1501-RP33 \$450	PLS-2501-RP33 \$490
30x0.8mm	50x0.8mm	100x0.8mm	150x0.8mm	250x0.8mm
PLS-03M8-RP33 \$375	PLS-05M8-RP33 \$385	PLS-10M8-RP33 \$420	PLS-15M8-RP33 \$450	PLS-25M8-RP33 \$490
30x0.5mm	50x0.5mm	100x0.5mm	150x0.5mm	250x0.5mm
PLS-03M5-RP33 \$375	PLS-05M5-RP33 \$385	PLS-10M5-RP33 \$420	PLS-15M5-RP33 \$450	PLS-25M5-RP33 \$490
30x0.3mm	50x0.3mm	100x0.3mm	150x0.3mm	250x0.3mm
PLS-03M3-RP33 \$375	PLS-05M3-RP33 \$385	PLS-10M3-RP33 \$420	PLS-15M3-RP33 \$450	PLS-25M3-RP33 \$490

POLYMERIC PLRP-S 1000Å 5µm

30x1.0mm	50x1.0mm	100x1.0mm	150x1.0mm	250x1.0mm
PLS-0301-RP1K5 \$375	PLS-0501-RP1K5 \$385	PLS-1001-RP1K5 \$420	PLS-1501-RP1K5 \$450	PLS-2501-RP1K5 \$490
30x0.8mm	50x0.8mm	100x0.8mm	150x0.8mm	250x0.8mm
PLS-03M8-RP1K5 \$375	PLS-05M8-RP1K5 \$385	PLS-10M8-RP1K5 \$420	PLS-15M8-RP1K5 \$450	PLS-25M8-RP1K5 \$490
30x0.5mm	50x0.5mm	100x0.5mm	150x0.5mm	250x0.5mm
PLS-03M5-RP1K5 \$375	PLS-05M5-RP1K5 \$385	PLS-10M5-RP1K5 \$420	PLS-15M5-RP1K5 \$450	PLS-25M5-RP1K5 \$490
30x0.3mm	50x0.3mm	100x0.3mm	150x0.3mm	250x0.3mm
PLS-03M3-RP1K5 \$375	PLS-05M3-RP1K5 \$385	PLS-10M3-RP1K5 \$420	PLS-15M3-RP1K5 \$450	PLS-25M3-RP1K5 \$490

POLYMERIC PLRP-S 4000Å 5µm

30x1.0mm	50x1.0mm	100x1.0mm	150x1.0mm	250x1.0mm
PLS-0301-RP4K5 \$375	PLS-0501-RP4K5 \$385	PLS-1001-RP4K5 \$420	PLS-1501-RP4K5 \$450	PLS-2501-RP4K5 \$490
30x0.8mm	50x0.8mm	100x0.8mm	150x0.8mm	250x0.8mm
PLS-03M8-RP4K5 \$375	PLS-05M8-RP4K5 \$385	PLS-10M8-RP4K5 \$420	PLS-15M8-RP4K5 \$450	PLS-25M8-RP4K5 \$490
30x0.5mm	50x0.5mm	100x0.5mm	150x0.5mm	250x0.5mm
PLS-03M5-RP4K5 \$375	PLS-05M5-RP4K5 \$385	PLS-10M5-RP4K5 \$420	PLS-15M5-RP4K5 \$450	PLS-25M5-RP4K5 \$490
30x0.3mm	50x0.3mm	100x0.3mm	150x0.3mm	250x0.3mm
PLS-03M3-RP4K5 \$375	PLS-05M3-RP4K5 \$385	PLS-10M3-RP4K5 \$420	PLS-15M3-RP4K5 \$450	PLS-25M3-RP4K5 \$490



Microbore HPLC Columns (continued)

Wide Range of 1mm, 0.5mm, and 0.3mm Columns



POLYMERIC Strong Anion Exchange Microbore Columns

POLYMERIC SAX 1000Å 5µm

30x1.0mm		50x1.0mm		100x1.0mm		150x1.0mm		250x1.0mm	
PLS-0301-AX1K5	\$375	PLS-0501-AX1K5	\$385	PLS-1001-AX1K5	\$420	PLS-1501-AX1K5	\$450	PLS-2501-AX1K5	\$490
30x0.8mm		50x0.8mm		100x0.8mm		150x0.8mm		250x0.8mm	
PLS-03M8-AX1K5	\$375	PLS-05M8-AX1K5	\$385	PLS-10M8-AX1K5	\$420	PLS-15M8-AX1K5	\$450	PLS-25M8-AX1K5	\$490
30x0.5mm		50x0.5mm		100x0.5mm		150x0.5mm		250x0.5mm	
PLS-03M5-AX1K5	\$375	PLS-05M5-AX1K5	\$385	PLS-10M5-AX1K5	\$420	PLS-15M5-AX1K5	\$450	PLS-25M5-AX1K5	\$490
30x0.3mm		50x0.3mm		100x0.3mm		150x0.3mm		250x0.3mm	
PLS-03M3-AX1K5	\$375	PLS-05M3-AX1K5	\$385	PLS-10M3-AX1K5	\$420	PLS-15M3-AX1K5	\$450	PLS-25M3-AX1K5	\$490

POLYMERIC SAX 4000Å 5µm

30x1.0mm		50x1.0mm		100x1.0mm		150x1.0mm		250x1.0mm	
PLS-0301-AX4K5	\$375	PLS-0501-AX4K5	\$385	PLS-1001-AX4K5	\$420	PLS-1501-AX4K5	\$450	PLS-2501-AX4K5	\$490
30x0.8mm		50x0.8mm		100x0.8mm		150x0.8mm		250x0.8mm	
PLS-03M8-AX4K5	\$375	PLS-05M8-AX4K5	\$385	PLS-10M8-AX4K5	\$420	PLS-15M8-AX4K5	\$450	PLS-25M8-AX4K5	\$490
30x0.5mm		50x0.5mm		100x0.5mm		150x0.5mm		250x0.5mm	
PLS-03M5-AX4K5	\$375	PLS-05M5-AX4K5	\$385	PLS-10M5-AX4K5	\$420	PLS-15M5-AX4K5	\$450	PLS-25M5-AX4K5	\$490
30x0.3mm		50x0.3mm		100x0.3mm		150x0.3mm		250x0.3mm	
PLS-03M3-AX4K5	\$375	PLS-05M3-AX4K5	\$385	PLS-10M3-AX4K5	\$420	PLS-15M3-AX4K5	\$450	PLS-25M3-AX4K5	\$490

POLYMERIC Strong Cation Exchange Microbore Columns

POLYMERIC SCX 1000Å 5µm

30x1.0mm		50x1.0mm		100x1.0mm		150x1.0mm		250x1.0mm	
PLS-0301-SCX1K5	\$375	PLS-0501-SCX1K5	\$385	PLS-1001-SCX1K5	\$420	PLS-1501-SCX1K5	\$450	PLS-2501-SCX1K5	\$490
30x0.8mm		50x0.8mm		100x0.8mm		150x0.8mm		250x0.8mm	
PLS-03M8-SCX1K5	\$375	PLS-05M8-SCX1K5	\$385	PLS-10M8-SCX1K5	\$420	PLS-15M8-SCX1K5	\$450	PLS-25M8-SCX1K5	\$490
30x0.5mm		50x0.5mm		100x0.5mm		150x0.5mm		250x0.5mm	
PLS-03M5-SCX1K5	\$375	PLS-05M5-SCX1K5	\$385	PLS-10M5-SCX1K5	\$420	PLS-15M5-SCX1K5	\$450	PLS-25M5-SCX1K5	\$490
30x0.3mm		50x0.3mm		100x0.3mm		150x0.3mm		250x0.3mm	
PLS-03M3-SCX1K5	\$375	PLS-05M3-SCX1K5	\$385	PLS-10M3-SCX1K5	\$420	PLS-15M3-SCX1K5	\$450	PLS-25M3-SCX1K5	\$490

POLYMERIC SCX 4000Å 5µm

30x1.0mm		50x1.0mm		100x1.0mm		150x1.0mm		250x1.0mm	
PLS-0301-SCX4K5	\$375	PLS-0501-SCX4K5	\$385	PLS-1001-SCX4K5	\$420	PLS-1501-SCX4K5	\$450	PLS-2501-SCX4K5	\$490
30x0.8mm		50x0.8mm		100x0.8mm		150x0.8mm		250x0.8mm	
PLS-03M8-SCX4K5	\$375	PLS-05M8-SCX4K5	\$385	PLS-10M8-SCX4K5	\$420	PLS-15M8-SCX4K5	\$450	PLS-25M8-SCX4K5	\$490
30x0.5mm		50x0.5mm		100x0.5mm		150x0.5mm		250x0.5mm	
PLS-03M5-SCX4K5	\$375	PLS-05M5-SCX4K5	\$385	PLS-10M5-SCX4K5	\$420	PLS-15M5-SCX4K5	\$450	PLS-25M5-SCX4K5	\$490
30x0.3mm		50x0.3mm		100x0.3mm		150x0.3mm		250x0.3mm	
PLS-03M3-SCX4K5	\$375	PLS-05M3-SCX4K5	\$385	PLS-10M3-SCX4K5	\$420	PLS-15M3-SCX4K5	\$450	PLS-25M3-SCX4K5	\$490

POLYMERIC Weak Anion Exchange Microbore Columns

POLYMERIC WAX 1000Å 5µm

30x1.0mm	50x1.0mm	100x1.0mm	150x1.0mm	250x1.0mm
PLS-0301-WAX1K5 \$375	PLS-0501-WAX1K5 \$385	PLS-1001-WAX1K5 \$420	PLS-1501-WAX1K5 \$450	PLS-2501-WAX1K5 \$490
30x0.8mm	50x0.8mm	100x0.8mm	150x0.8mm	250x0.8mm
PLS-03M8-WAX1K5 \$375	PLS-05M8-WAX1K5 \$385	PLS-10M8-WAX1K5 \$420	PLS-15M8-WAX1K5 \$450	PLS-25M8-WAX1K5 \$490
30x0.5mm	50x0.5mm	100x0.5mm	150x0.5mm	250x0.5mm
PLS-03M5-WAX1K5 \$375	PLS-05M5-WAX1K5 \$385	PLS-10M5-WAX1K5 \$420	PLS-15M5-WAX1K5 \$450	PLS-25M5-WAX1K5 \$490
30x0.3mm	50x0.3mm	100x0.3mm	150x0.3mm	250x0.3mm
PLS-03M3-WAX1K5 \$375	PLS-05M3-WAX1K5 \$385	PLS-10M3-WAX1K5 \$420	PLS-15M3-WAX1K5 \$450	PLS-25M3-WAX1K5 \$490

POLYMERIC WAX 4000Å 5µm

30x1.0mm	50x1.0mm	100x1.0mm	150x1.0mm	250x1.0mm
PLS-0301-WAX4K5 \$375	PLS-0501-WAX4K5 \$385	PLS-1001-WAX4K5 \$420	PLS-1501-WAX4K5 \$450	PLS-2501-WAX4K5 \$490
30x0.8mm	50x0.8mm	100x0.8mm	150x0.8mm	250x0.8mm
PLS-03M8-WAX4K5 \$375	PLS-05M8-WAX4K5 \$385	PLS-10M8-WAX4K5 \$420	PLS-15M8-WAX4K5 \$450	PLS-25M8-WAX4K5 \$490
30x0.5mm	50x0.5mm	100x0.5mm	150x0.5mm	250x0.5mm
PLS-03M5-WAX4K5 \$375	PLS-05M5-WAX4K5 \$385	PLS-10M5-WAX4K5 \$420	PLS-15M5-WAX4K5 \$450	PLS-25M5-WAX4K5 \$490
30x0.3mm	50x0.3mm	100x0.3mm	150x0.3mm	250x0.3mm
PLS-03M3-WAX4K5 \$375	PLS-05M3-WAX4K5 \$385	PLS-10M3-WAX4K5 \$420	PLS-15M3-WAX4K5 \$450	PLS-25M3-WAX4K5 \$490

POLYMERIC Weak Cation Exchange Microbore Columns

POLYMERIC WCX 1000Å 5µm

30x1.0mm	50x1.0mm	100x1.0mm	150x1.0mm	250x1.0mm
PLS-0301-WCX1K5 \$375	PLS-0501-WCX1K5 \$385	PLS-1001-WCX1K5 \$420	PLS-1501-WCX1K5 \$450	PLS-2501-WCX1K5 \$490
30x0.8mm	50x0.8mm	100x0.8mm	150x0.8mm	250x0.8mm
PLS-03M8-WCX1K5 \$375	PLS-05M8-WCX1K5 \$385	PLS-10M8-WCX1K5 \$420	PLS-15M8-WCX1K5 \$450	PLS-25M8-WCX1K5 \$490
30x0.5mm	50x0.5mm	100x0.5mm	150x0.5mm	250x0.5mm
PLS-03M5-WCX1K5 \$375	PLS-05M5-WCX1K5 \$385	PLS-10M5-WCX1K5 \$420	PLS-15M5-WCX1K5 \$450	PLS-25M5-WCX1K5 \$490
30x0.3mm	50x0.3mm	100x0.3mm	150x0.3mm	250x0.3mm
PLS-03M3-WCX1K5 \$375	PLS-05M3-WCX1K5 \$385	PLS-10M3-WCX1K5 \$420	PLS-15M3-WCX1K5 \$450	PLS-25M3-WCX1K5 \$490

POLYMERIC WCX 4000Å 5µm

30x1.0mm	50x1.0mm	100x1.0mm	150x1.0mm	250x1.0mm
PLS-0301-WCX4K5 \$375	PLS-0501-WCX4K5 \$385	PLS-1001-WCX4K5 \$420	PLS-1501-WCX4K5 \$450	PLS-2501-WCX4K5 \$490
30x0.8mm	50x0.8mm	100x0.8mm	150x0.8mm	250x0.8mm
PLS-03M8-WCX4K5 \$375	PLS-05M8-WCX4K5 \$385	PLS-10M8-WCX4K5 \$420	PLS-15M8-WCX4K5 \$450	PLS-25M8-WCX4K5 \$490
30x0.5mm	50x0.5mm	100x0.5mm	150x0.5mm	250x0.5mm
PLS-03M5-WCX4K5 \$375	PLS-05M5-WCX4K5 \$385	PLS-10M5-WCX4K5 \$420	PLS-15M5-WCX4K5 \$450	PLS-25M5-WCX4K5 \$490
30x0.3mm	50x0.3mm	100x0.3mm	150x0.3mm	250x0.3mm
PLS-03M3-WCX4K5 \$375	PLS-05M3-WCX4K5 \$385	PLS-10M3-WCX4K5 \$420	PLS-15M3-WCX4K5 \$450	PLS-25M3-WCX4K5 \$490





Semi-Prep (10mm) and Prep (20mm) Columns

Not only does Higgins Analytical manufacturer semi-prep and prep columns with our most popular phases, we also produce guard cartridges these columns.

See pages 60 - 61 (10mm) and 72 - 73 (20mm) for more information about guard cartridges.

Guide to Semi-Prep and Prep Column Part Numbers

xS-xx10-xxxx 10mm I.D. columns

xS-xx20-xxxx 20mm I.D. columns

See Page 23 for complete Part Number information

CLIQUEUS 10mm Semi-Prep and 20mm Prep Columns



CLIQUEUS C8 5µm	10 and 20mm I.D. s.s. columns							
	50x10mm		100x10mm		150x10mm		250x10mm	
	CS-0510-C085	\$470	CS-1010-C085	\$590	CS-1510-C085	\$855	CS-2510-C085	\$1065
	50x20mm		100x20mm		150x20mm		250x20mm	
	CS-0520-C085	\$1195	CS-1020-C085	\$1495	CS-1520-C085	\$1975	CS-2520-C085	\$2560
CLIQUEUS C18 10µm	10 and 20mm I.D. s.s. columns							
	50x10mm		100x10mm		150x10mm		250x10mm	
	CS-0510-C181	\$320	CS-1010-C181	\$395	CS-1510-C181	\$565	CS-2510-C181	\$715
	50x20mm		100x20mm		150x20mm		250x20mm	
	CS-0520-C181	\$805	CS-1020-C181	\$1010	CS-1520-C181	\$1310	CS-2520-C181	\$1705
CLIQUEUS C18 5µm	10 and 20mm I.D. s.s. columns							
	50x10mm		100x10mm		150x10mm		250x10mm	
	CS-0510-C185	\$470	CS-1010-C185	\$590	CS-1510-C185	\$855	CS-2510-C185	\$1065
	50x20mm		100x20mm		150x20mm		250x20mm	
	CS-0520-C185	\$1195	CS-1020-C185	\$1495	CS-1520-C185	\$1975	CS-2520-C185	\$2560
CLIQUEUS Silica 10µm	10 and 20mm I.D. s.s. columns							
	50x10mm		100x10mm		150x10mm		250x10mm	
	CS-0510-SIL1	\$300	CS-1010-SIL1	\$370	CS-1510-SIL1	\$530	CS-2510-SIL1	\$670
	50x20mm		100x20mm		150x20mm		250x20mm	
	CS-0520-SIL1	\$755	CS-1020-SIL1	\$950	CS-1520-SIL1	\$1230	CS-2520-SIL1	\$1600
CLIQUEUS Silica 5µm	10 and 20mm I.D. s.s. columns							
	50x10mm		100x10mm		150x10mm		250x10mm	
	CS-0510-SIL5	\$440	CS-1010-SIL5	\$550	CS-1510-SIL5	\$800	CS-2510-SIL5	\$1000
	50x20mm		100x20mm		150x20mm		250x20mm	
	CS-0520-SIL5	\$1120	CS-1020-SIL5	\$1400	CS-1520-SIL5	\$1855	CS-2520-SIL5	\$2400



HAISIL100 10mm Semi-Prep and 20mm Prep Columns



HAISIL 100 C8 5µm		10 and 20mm I.D. s.s. columns							
50x10mm		100x10mm		150x10mm		250x10mm			
HS-0510-M085	\$350	HS-1010-M085	\$405	HS-1510-M085	\$456	HS-2510-M085	\$695		
50x20mm		100x20mm		150x20mm		250x20mm			
HS-0520-M085	\$855	HS-1020-M085	\$880	HS-1520-M085	\$1065	HS-2520-M085	\$1950		

HAISIL 100 C18 5µm

10 and 20mm I.D. s.s. columns

50x10mm		100x10mm		150x10mm		250x10mm			
HS-0510-M185	\$350	HS-1010-M185	\$405	HS-1510-M185	\$456	HS-2510-M185	\$695		
50x20mm		100x20mm		150x20mm		250x20mm			
HS-0520-M185	\$855	HS-1020-M185	\$880	HS-1520-M185	\$1065	HS-2520-M185	\$1950		

PHALANX 10mm Semi-Prep and 20mm Prep Columns



PHALANX C18 10µm		10 and 20mm I.D. s.s. columns							
50x10mm		100x10mm		150x10mm		250x10mm			
PS-0510-C181	\$360	PS-1010-C181	\$415	PS-1510-C181	\$610	PS-2510-C181	\$760		
50x20mm		100x20mm		150x20mm		250x20mm			
PS-0520-C181	\$890	PS-1020-C181	\$1030	PS-1520-C181	\$1380	PS-2520-C181	\$1800		

PHALANX C18 5µm

10 and 20mm I.D. s.s. columns

50x10mm		100x10mm		150x10mm		250x10mm			
PS-0510-C185	\$545	PS-1010-C185	\$630	PS-1510-C185	\$920	PS-2510-C185	\$1155		
50x20mm		100x20mm		150x20mm		250x20mm			
PS-0520-C185	\$1350	PS-1020-C185	\$1565	PS-1520-C185	\$2090	PS-2520-C185	\$2730		

PROTO 200 10mm Semi-Prep and 20mm Prep Columns

200

PROTO 200 C4 10µm		10 and 20mm I.D. s.s. columns							
50x10mm		100x10mm		150x10mm		250x10mm			
RS-0510-D041	\$310	RS-1010-D041	\$390	RS-1510-D041	\$565	RS-2510-D041	\$700		
50x20mm		100x20mm		150x20mm		250x20mm			
RS-0520-D041	\$790	RS-1020-D041	\$990	RS-1520-D041	\$1300	RS-2520-D041	\$1700		

PROTO 200 C4 5µm

10 and 20mm I.D. s.s. columns

50x10mm		100x10mm		150x10mm		250x10mm			
RS-0510-D045	\$470	RS-1010-D045	\$590	RS-1510-D045	\$855	RS-2510-D045	\$1065		
50x20mm		100x20mm		150x20mm		250x20mm			
RS-0520-D045	\$1195	RS-1020-D045	\$1495	RS-1520-D045	\$1975	RS-2520-D045	\$2560		

PROTO 200 C18 10µm

10 and 20mm I.D. s.s. columns

50x10mm		100x10mm		150x10mm		250x10mm			
RS-0510-D181	\$310	RS-1010-D181	\$390	RS-1510-D181	\$565	RS-2510-D181	\$700		
50x20mm		100x20mm		150x20mm		250x20mm			
RS-0520-D181	\$790	RS-1020-D181	\$990	RS-1520-D181	\$1300	RS-2520-D181	\$1700		

PROTO 200 C18 5µm

10 and 20mm I.D. s.s. columns

50x10mm		100x10mm		150x10mm		250x10mm			
RS-0510-D185	\$470	RS-1010-D185	\$590	RS-1510-D185	\$855	RS-2510-D185	\$1065		
50x20mm		100x20mm		150x20mm		250x20mm			
RS-0520-D185	\$1195	RS-1020-D185	\$1495	RS-1520-D185	\$1975	RS-2520-D185	\$2560		



PROTO 300 10mm Semi-Prep and 20mm Prep Columns



PROTO 300 C4 10μm		10 and 20mm I.D. s.s. columns					
50x10mm		100x10mm		150x10mm		250x10mm	
RS-0510-W041	\$310	RS-1010-W041	\$390	RS-1510-W041	\$565	RS-2510-W041	\$700
50x20mm		100x20mm		150x20mm		250x20mm	
RS-0520-W041	\$790	RS-1020-W041	\$990	RS-1520-W041	\$1300	RS-2520-W041	\$1700

PROTO 300 C4 5μm		10 and 20mm I.D. s.s. columns					
50x10mm		100x10mm		150x10mm		250x10mm	
RS-0510-W045	\$470	RS-1010-W045	\$590	RS-1510-W045	\$855	RS-2510-W045	\$1065
50x20mm		100x20mm		150x20mm		250x20mm	
RS-0520-W045	\$1195	RS-1020-W045	\$1495	RS-1520-W045	\$1975	RS-2520-W045	\$2560

PROTO 300 C18 10μm		10 and 20mm I.D. s.s. columns					
50x10mm		100x10mm		150x10mm		250x10mm	
RS-0510-W181	\$310	RS-1010-W181	\$390	RS-1510-W181	\$565	RS-2510-W181	\$700
50x20mm		100x20mm		150x20mm		250x20mm	
RS-0520-W181	\$790	RS-1020-W181	\$990	RS-1520-W181	\$1300	RS-2520-W181	\$1700

PROTO 300 C18 5μm		10 and 20mm I.D. s.s. columns					
50x10mm		100x10mm		150x10mm		250x10mm	
RS-0510-W185	\$470	RS-1010-W185	\$590	RS-1510-W185	\$855	RS-2510-W185	\$1065
50x20mm		100x20mm		150x20mm		250x20mm	
RS-0520-W185	\$1195	RS-1020-W185	\$1495	RS-1520-W185	\$1975	RS-2520-W185	\$2560

TARGA 10mm Semi-Prep and 20mm Prep Columns



TARGA C18 10μm		10 and 20mm I.D. s.s. columns					
50x10mm		100x10mm		150x10mm		250x10mm	
TS-0510-C181	\$310	TS-1010-C181	\$390	TS-1510-C181	\$565	TS-2510-C181	\$700
50x20mm		100x20mm		150x20mm		250x20mm	
TS-0520-C181	\$790	TS-1020-C181	\$990	TS-1520-C181	\$1300	TS-2520-C181	\$1700

TARGA C18 5μm		10 and 20mm I.D. s.s. columns					
50x10mm		100x10mm		150x10mm		250x10mm	
TS-0510-C185	\$470	TS-1010-C185	\$590	TS-1510-C185	\$855	TS-2510-C185	\$1065
50x20mm		100x20mm		150x20mm		250x20mm	
TS-0520-C185	\$1195	TS-1020-C185	\$1495	TS-1520-C185	\$1975	TS-2520-C185	\$2560

See pages 58 - 59 and 64 - 65 for information about Guard Cartridges available for these Prep and Semi-Prep Columns



See pages 72 - 73 for information about the Prep and Semi-Prep Cartridge Holders



Prep Scale (20mm)

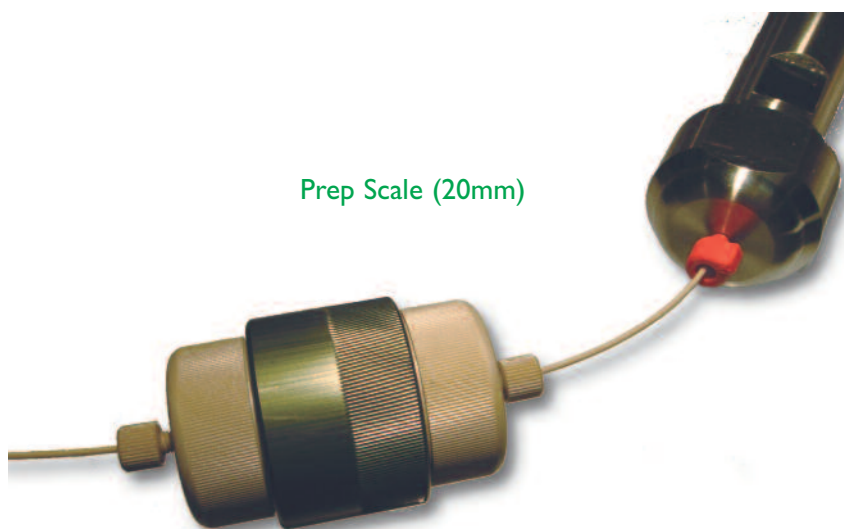

Prep Scale (20mm)

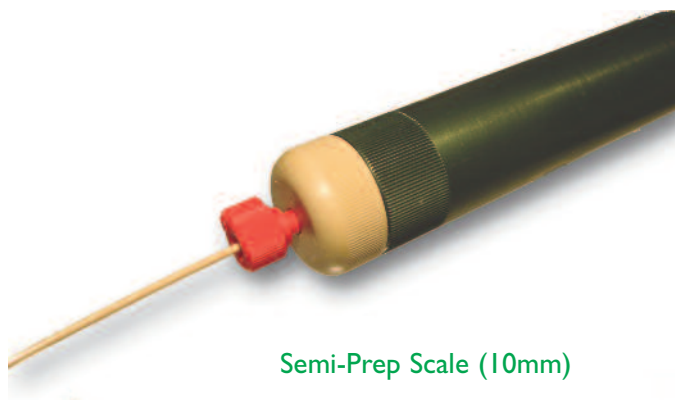

Semi-Prep Scale (10mm)



Capillary™
CAPILLARY HPLC COLUMNS

A New Benchmark in Capillary Column Quality and Cost:

Higgins Analytical's unique approach provides a flexible format and reasonably priced capillary HPLC column for LC-MS applications. Capillary, π , columns are all manufactured and tested as 250mm products and are offered for the reasonable price of \$314.16 for both 75 μ m and 150 μ m versions.

NEW

\$314.16

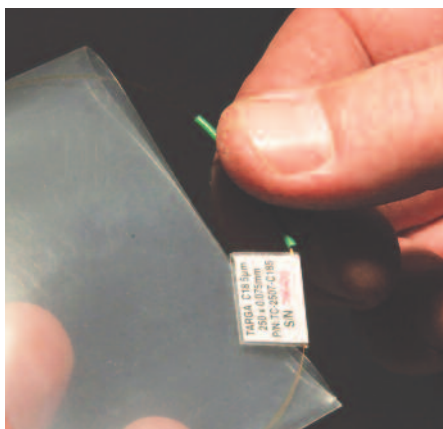

Cutting and trimming a Capillary™ Column:

The Capillaries can be used as is, or they can be easily cut to any required length, with a ceramic cutter that is included with each column. Capillary™ columns are nominally 25cm in length. Unless the capillary is going to be used in its full length, the white ceramic cutter is used to cut the column to the required size. Measure from the frit in the center of the green section. This technique can also be useful for removing a short section from the column inlet if it becomes contaminated or plugged. Similarly, the column outlet can be trimmed to a proper length before attaching it to the post-column device.



TARGA C18 5 μ m
 250 x 0.075mm
 P/N:TC-2507-C185
 S/N 166A35

Plumbing Considerations:

The Capillary™ 75 and Capillary™ 150 columns have standard 360 μ m outer diameters which can be conveniently plumbed to HPLC systems in a wide variety of manners. The optional Higgins Micro Column Connection Kit (PIN MIC-KIT, see page 74) includes sleeves and finger-tight bushings to facilitate capillary column attachment to most injection valves, detectors, and MS source inlets.

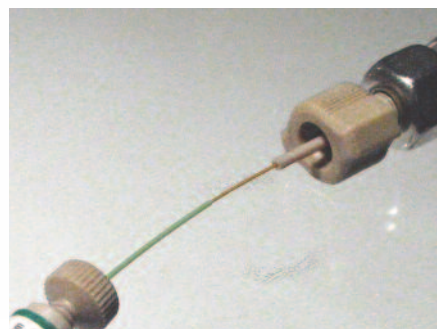
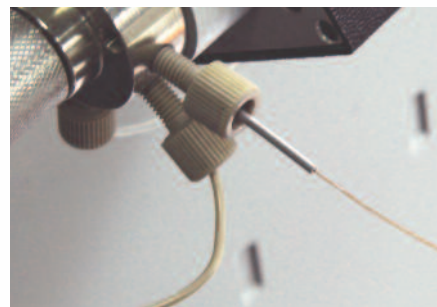

Robust design with High Performance:

To the right, aBSA tryptic digest on a 150cm x 75 μ m Targa C18 5 μ m Capillary. P/N TC-2507-C185 cut to 15cm.

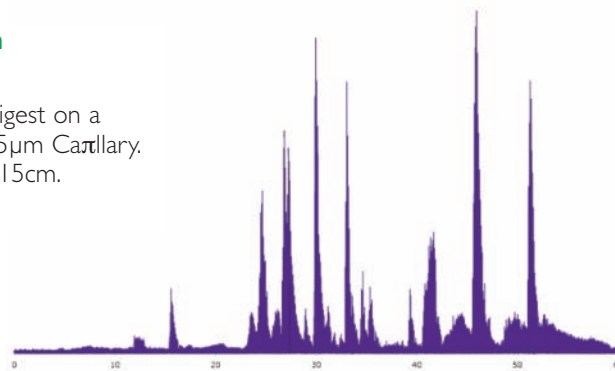

HAISIL 300 C18 5µm



250x0.075mm	
HC-2507-W185	\$314.16
250x0.150mm	
HC-2515-W185	\$314.16

HAISIL HL C18 5µm



250x0.075mm	
LC-2507-C185	\$314.16
250x0.150mm	
LC-2515-C185	\$314.16

HEAVY C18 5µm



250x0.075mm	
VC-2507-C185	\$314.16
250x0.150mm	
VC-2515-C185	\$314.16

PROTO 200 C4 5µm



250x0.075mm	
RC-2507-D045	\$314.16
250x0.150mm	
RC-2515-D045	\$314.16

PROTO 200 C18 5µm

250x0.075mm	
RC-2507-D185	\$314.16
250x0.150mm	
RC-2515-D185	\$314.16

PROTO 300 C4 5µm/75µm and 150µm



250x0.075mm	
RC-2507-W045	\$314.16
250x0.150mm	
RC-2515-W045	\$314.16

PROTO 300 C18 5µm/75µm and 150µm

250x0.075mm	
RC-2507-W185	\$314.16
250x0.150mm	
RC-2515-W185	\$314.16

PHALANX C18 5µm/75µm and 150µm



250x0.075mm	
PC-2507-C185	\$314.16
250x0.150mm	
PC-2515-C185	\$314.16

TARGA C8 5µm/75µm and 150µm



250x0.075mm	
TC-2507-C085	\$314.16
250x0.150mm	
TC-2515-C085	\$314.16

TARGA C18 5µm

250x0.075mm	
TC-2507-C185	\$314.16
250x0.150mm	
TC-2515-C185	\$314.16

POLYMERIC PLRP-S 100Å 3µm

250x0.075mm	
PLC-2507-RP13	\$314.16
250x0.150mm	
PLC-2515-RP13	\$314.16

POLYMERIC PLRP-S 300Å 3µm

250x0.075mm	
PLC-2507-RP33	\$314.16
250x0.150mm	
PLC-2515-RP33	\$314.16

POLYMERIC PLRP-S 1000Å 5µm

250x0.075mm	
PLC-2507-RP1K5	\$314.16
250x0.150mm	
PLC-2515-RP1K5	\$314.16

POLYMERIC PLRP-S 4000Å 5µm

250x0.075mm	
PLC-2507-RP4K5	\$314.16
250x0.150mm	
PLC-2515-RP4K5	\$314.16

POLYMERIC SAX 1000Å 5µm

250x0.075mm	
PLC-2507-AX1K5	\$314.16
250x0.150mm	
PLC-2515-AX1K5	\$314.16

POLYMERIC SAX 4000Å 5µm

250x0.075mm	
PLC-2507-AX4K5	\$314.16
250x0.150mm	
PLC-2515-AX4K5	\$314.16

POLYMERIC SCX 1000Å 5µm

250x0.075mm	
PLC-2507-SCX1K5	\$314.16
250x0.150mm	
PLC-2515-SCX1K5	\$314.16

POLYMERIC SCX 4000Å 5µm

250x0.075mm	
PLC-2507-SCX4K5	\$314.16
250x0.150	
PLC-2515-SCX4K5	\$314.16

POLYMERIC WAX 1000Å 5µm

250x0.075mm	
PLC-2507-WAX1K5	\$314.16
250x0.150mm	
PLC-2515-WAX1K5	\$314.16

POLYMERIC WAX 4000Å 5µm

250x0.075mm	
PLC-2507-WAX4K5	\$314.16
250x0.150mm	
PLC-2515-WAX4K5	\$314.16

POLYMERIC WCX 1000Å 5µm

250x0.075mm	
PLC-2507-WCX1K5	\$314.16
250x0.150mm	
PLC-2515-WCX1K5	\$314.16

POLYMERIC WCX 4000Å 5µm

250x0.075mm	
PLC-2507-WCX4K5	\$314.16
250x0.150mm	
PLC-2515-WCX4K5	\$314.16

CLIQUEUS C8 5µm



250x0.075mm	
CC-2507-C085	\$314.16
250x0.150mm	
CC-2515-C085	\$314.16

CLIQUEUS C18 5µm

250x0.075mm	
CC-2507-C185	\$314.16
250x0.150mm	
CC-2515-C185	\$314.16

CLIQUEUS CYANO 5µm

250x0.075mm	
CC-2507-CNP5	\$314.16
250x0.150mm	
CC-2515-CNP5	\$314.16

CLIQUEUS PHENYL 5µm

250x0.075mm	
CC-2507-PHN5	\$314.16
250x0.150mm	
CC-2515-PHN5	\$314.16

CLIQUEUS SILICA 5µm

250x0.075mm	
CC-2507-SIL5	\$314.16
250x0.150mm	
CC-2515-SIL5	\$314.16

HAISIL 100 C8 5µm



250x0.075mm	
HC-2507-M085	\$314.16
250x0.150mm	
HC-2515-M085	\$314.16

HAISIL 100 C18 5µm

250x0.075mm	
HC-2507-M185	\$314.16
250x0.150mm	
HC-2515-M185	\$314.16

HAISIL 100 SILICA 5µm

250x0.075mm	
HC-2507-SIL5	\$314.16
250x0.150mm	
HC-2515-SIL5	\$314.16

CAPELLINI

CAPILLARY HPLC COLUMNS



Capillary HPLC Columns

Applications:

- LC-MS
- Microbore HPLC

Unique Features:

- Tested and supplied with CofA
- PEEK/Titanium fittings
- High performance
- 6-32 threads for capillary fittings
- Higgins Analytical Sorbents

Standard Sizes:

- 50 to 150 x 0.150mm
- 50 to 150 x 0.075mm
- Longer and shorter lengths available

Guide to CAPELLINI Part Numbers

xC-xx07-xxxx 75µm CAPELLINI
 xC-xx15-xxxx 150µm CAPELLINI

See Page 23 for complete Part Number information

Higgins Analytical Capellini columns are robust and high performance capillary HPLC columns for LC-MS and other very small scale applications. The inert PEEK and titanium fittings complement the Higgins Analytical sorbents such as TARGA which was developed to enable LC-MS applications without TFA.

Our no nonsense testing procedure does not resort to sample and flow splitting techniques, inaccurate *k'* values, and miniscule chromatograms, as do some manufacturers, to illustrate column performance. The CofA's symmetrical peaks and the high resolution map speak for themselves.

Capellini - Back by Popular Demand

When Higgins Analytical introduced Capillary two years ago, we removed Capellini from our catalog, however, we continued to manufacture this design for customers that had been using it for several years. Somewhat to our surprise, Capellini sales have continued to grow and we still receive numerous product inquiries in spite of their absence from our literature. While Capillary columns are very efficient and cost effective (see page 42), we have found that many chromatographers prefer the symmetrical, flow reversible design and the 6-32 threaded end-fittings of Capellini. Even though Capellini are more expensive to manufacture and somewhat less efficient than Capillary columns, due to the end fitting design, they enjoy a wide variety of uses that involve flow reversal, such as trap applications.

High Selectivity:

A partial 1.5µL/min LCMSMS map of a BSA tryptic digest.

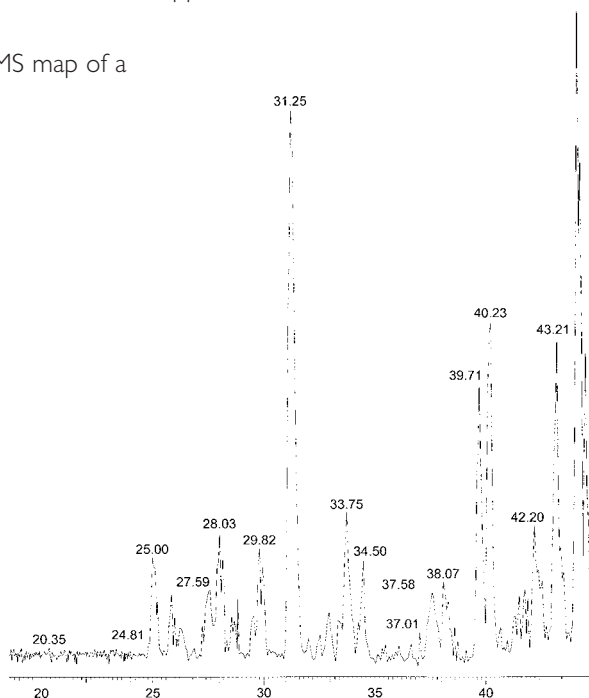

CLIQUEUS Capillary Columns

CLIQUEUS C8 5µm		75µm and 150µm Capillary columns					
		50x0.075mm		100x0.075mm		150x0.075mm	
	CC-0507-C085	\$400		CC-1007-C085	\$400	CC-1507-C085	\$400
		50x0.150mm		100x0.150mm		150x0.150mm	
	CC-0515-C085	\$400		CC-1015-C085	\$400	CC-1515-C085	\$400

CLIQUEUS C18 5µm		75µm and 150µm Capillary columns					
		50x0.075mm		100x0.075mm		150x0.075mm	
	CC-0507-C185	\$400		CC-1007-C185	\$400	CC-1507-C185	\$400
		50x0.150mm		100x0.150mm		150x0.150mm	
	CC-0515-C185	\$400		CC-1015-C185	\$400	CC-1515-C185	\$400

CLIQUEUS Cyano 5µm		75µm and 150µm Capillary columns					
		50x0.075mm		100x0.075mm		150x0.075mm	
	CC-0507-CNP5	\$400		CC-1007-CNP5	\$400	CC-1507-CNP5	\$400
		50x0.150mm		100x0.150mm		150x0.150mm	
	CC-0515-CNP5	\$400		CC-1015-CNP5	\$400	CC-1515-CNP5	\$400

CLIQUEUS Phenyl 5µm		75µm and 150µm Capillary columns					
		50x0.075mm		100x0.075mm		150x0.075mm	
	CC-0507-PHN5	\$400		CC-1007-PHN5	\$400	CC-1507-PHN5	\$400
		50x0.150mm		100x0.150mm		150x0.150mm	
	CC-0515-PHN5	\$400		CC-1015-PHN5	\$400	CC-1515-PHN5	\$400

CLIQUEUS Silica 5µm		75µm and 150µm Capillary columns					
		50x0.075mm		100x0.075mm		150x0.075mm	
	CC-0507-SIL5	\$400		CC-1007-SIL5	\$400	CC-1507-SIL5	\$400
		50x0.150mm		100x0.150mm		150x0.150mm	
	CC-0515-SIL5	\$400		CC-1015-SIL5	\$400	CC-1515-SIL5	\$400

HAISILI00 Capillary Columns

HAISIL 100 C8 5µm		75µm and 150µm Capillary columns					
		50x0.075mm		100x0.075mm		150x0.075mm	
	HC-0507-M085	\$400		HC-1007-M085	\$400	HC-1507-M085	\$400
		50x0.150mm		100x0.150mm		150x0.150mm	
	HC-0515-M085	\$400		HC-1015-M085	\$400	HC-1515-M085	\$400

HAISIL 100 C18 5µm		75µm and 150µm Capillary columns					
		50x0.075mm		100x0.075mm		150x0.075mm	
	HC-0507-M185	\$400		HC-1007-M185	\$400	HC-1507-M185	\$400
		50x0.150mm		100x0.150mm		150x0.150mm	
	HC-0515-M185	\$400		HC-1015-M185	\$400	HC-1515-M185	\$400

HAISIL 100 Silica 5µm		75µm and 150µm Capillary columns					
		50x0.075mm		100x0.075mm		150x0.075mm	
	HC-0507-SIL5	\$400		HC-1007-SIL5	\$400	HC-1507-SIL5	\$400
		50x0.150mm		100x0.150mm		150x0.150mm	
	HC-0515-SIL5	\$400		HC-1015-SIL5	\$400	HC-1515-SIL5	\$400



CAPELLINI

CAPILLARY HPLC COLUMNS



HAISIL300 Capillary Columns

HAISIL 300 C18 5µm	75µm and 150µm Capillary columns					
50x0.075mm			100x0.075mm			150x0.075mm
HC-0507-W185	\$400		HC-1007-W185	\$400		HC-1507-W185
50x0.150mm			100x0.150mm			150x0.150mm
HC-0515-W185	\$400		HC-1015-W185	\$400		HC-1515-W185

HAISIL HL Capillary Columns

HAISIL HL C18 5µm	75µm and 150µm Capillary columns					
50x0.075mm			100x0.075mm			150x0.075mm
LC-0507-C185	\$400		LC-1007-C185	\$400		LC-1507-C185
50x0.150mm			100x0.150mm			150x0.150mm
LC-0515-C185	\$400		LC-1015-C185	\$400		LC-1515-C185

HEAVY Capillary Columns

HEAVY C18 5µm	75µm and 150µm Capillary columns					
50x0.075mm			100x0.075mm			150x0.075mm
VC-0507-C185	\$400		VC-1007-C185	\$400		VC-1507-C185
50x0.150mm			100x0.150mm			150x0.150mm
VC-0515-C185	\$400		VC-1015-C185	\$400		VC-1515-C185

PROTO 200 Capillary Columns

PROTO 200 C4 5µm	75µm and 150µm Capillary columns					
50x0.075mm			100x0.075mm			150x0.075mm
RC-0507-D045	\$400		RC-1007-D045	\$400		RC-1507-D045
50x0.150mm			100x0.150mm			150x0.150mm
RC-0515-D045	\$400		RC-1015-D045	\$400		RC-1515-D045

PROTO 200 C18 5µm	75µm and 150µm Capillary columns					
50x0.075mm			100x0.075mm			150x0.075mm
RC-0507-D185	\$400		RC-1007-D185	\$400		RC-1507-D185
50x0.150mm			100x0.150mm			150x0.150mm
RC-0515-D185	\$400		RC-1015-D185	\$400		RC-1515-D185



PROTO 300 Capillary Columns

PROTO 300 C4 5µm	75µm and 150µm Capillary columns					
	50x0.075mm		100x0.075mm		150x0.075mm	
	RC-0507-W045	\$400	RC-1007-W045	\$400	RC-1507-W045	\$400
	50x0.150mm		100x0.150mm		150x0.150mm	
	RC-0515-W045	\$400	RC-1015-W045	\$400	RC-1515-W045	\$400

PROTO 300 C18 5µm	75µm and 150µm Capillary columns					
	50x0.075mm		100x0.075mm		150x0.075mm	
	RC-0507-W185	\$400	RC-1007-W185	\$400	RC-1507-W185	\$400
	50x0.150mm		100x0.150mm		150x0.150mm	
	RC-0515-W185	\$400	RC-1015-W185	\$400	RC-1515-W185	\$400

PHALANX Capillary Columns

PHALANX C18 5µm	75µm and 150µm Capillary columns					
	50x0.075mm		100x0.075mm		150x0.075mm	
	PC-0507-C185	\$400	PC-1007-C185	\$400	PC-1507-C185	\$400
	50x0.150mm		100x0.150mm		150x0.150mm	
	PC-0515-C185	\$400	PC-1015-C185	\$400	PC-1515-C185	\$400

TARGA Capillary Columns

TARGA C8 5µm	75µm and 150µm Capillary columns					
	50x0.075mm		100x0.075mm		150x0.075mm	
	TC-0507-C085	\$400	TC-1007-C085	\$400	TC-1507-C085	\$400
	50x0.150mm		100x0.150mm		150x0.150mm	
	TC-0515-C085	\$400	TC-1015-C085	\$400	TC-1515-C085	\$400

TARGA C18 3µm	75µm and 150µm Capillary columns					
	50x0.075mm		100x0.075mm		150x0.075mm	
	TC-0507-C183	\$400	TC-1007-C183	\$400	TC-1507-C183	\$400
	50x0.150mm		100x0.150mm		150x0.150mm	
	TC-0515-C183	\$400	TC-1015-C183	\$400	TC-1515-C183	\$400

TARGA C18 5µm	75µm and 150µm Capillary columns					
	50x0.075mm		100x0.075mm		150x0.075mm	
	TC-0507-C185	\$400	TC-1007-C185	\$400	TC-1507-C185	\$400
	50x0.150mm		100x0.150mm		150x0.150mm	
	TC-0515-C185	\$400	TC-1015-C185	\$400	TC-1515-C185	\$400

Robust design with High Performance:

To the right, aBSA tryptic digest on a 150cm x 75µm Targa C18 5µm Capellini. P/N TC-1507-C185

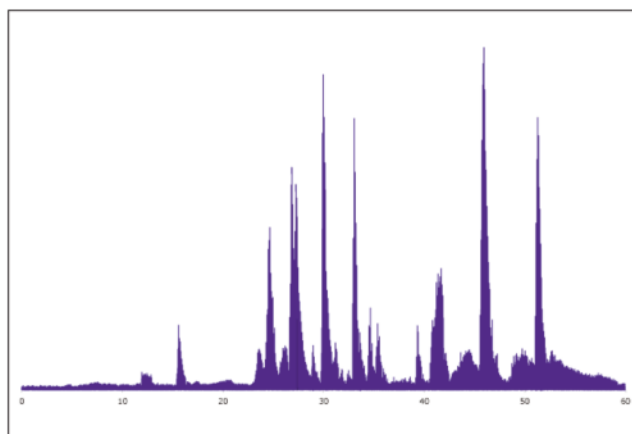

CAPELLINI

CAPILLARY HPLC COLUMNS

POLYMERIC Reverse Phase Microbore Columns

POLYMERIC PLRP-S 100Å 3µm

50x0.075mm		100x0.075mm		150x0.075mm	
PLC-0507-RP13	\$400	PLC-1007-RP13	\$400	PLC-1507-RP13	\$400
50x0.150mm		100x0.150mm		150x0.150mm	
PLC-0515-RP13	\$400	PLC-1015-RP13	\$400	PLC-1515-RP13	\$400

POLYMERIC PLRP-S 300Å 3µm

50x0.075mm		100x0.075mm		150x0.075mm	
PLC-0507-RP33	\$400	PLC-1007-RP33	\$400	PLC-1507-RP33	\$400
50x0.150mm		100x0.150mm		150x0.150mm	
PLC-0515-RP33	\$400	PLC-1015-RP33	\$400	PLC-1515-RP33	\$400

POLYMERIC PLRP-S 1000Å 5µm

50x0.075mm		100x0.075mm		150x0.075mm	
PLC-0507-RP1K5	\$400	PLC-1007-RP1K5	\$400	PLC-1507-RP1K5	\$400
50x0.150mm		100x0.150mm		150x0.150mm	
PLC-0515-RP1K5	\$400	PLC-1015-RP1K5	\$400	PLC-1515-RP1K5	\$400

POLYMERIC PLRP-S 4000Å 5µm

50x0.075mm		100x0.075mm		150x0.075mm	
PLC-0507-RP4K5	\$400	PLC-1007-RP4K5	\$400	PLC-1507-RP4K5	\$400
50x0.150mm		100x0.150mm		150x0.150mm	
PLC-0515-RP4K5	\$400	PLC-1015-RP4K5	\$400	PLC-1515-RP4K5	\$400

POLYMERIC Strong Anion Exchange Microbore Columns

POLYMERIC SAX 1000Å 5µm

50x0.075mm		100x0.075mm		150x0.075mm	
PLC-0507-AX1K5	\$400	PLC-1007-AX1K5	\$400	PLC-1507-AX1K5	\$400
50x0.150mm		100x0.150mm		150x0.150mm	
PLC-0515-AX1K5	\$400	PLC-1015-AX1K5	\$400	PLC-1515-AX1K5	\$400

POLYMERIC SAX 4000Å 5µm

50x0.075mm		100x0.075mm		150x0.075mm	
PLC-0507-AX4K5	\$400	PLC-1007-AX4K5	\$400	PLC-1507-AX4K5	\$400
50x0.150mm		100x0.150mm		150x0.150mm	
PLC-0515-AX4K5	\$400	PLC-1015-AX4K5	\$400	PLC-1515-AX4K5	\$400



POLYMERIC Strong Cation Exchange Microbore Columns

POLYMERIC SCX 1000Å 5µm

50x0.075mm	100x0.075mm	150x0.075mm
PLC-0507-SCX1K5 \$400	PLC-1007-SCX1K5 \$400	PLC-1507-SCX1K5 \$400
50x0.150mm	100x0.150mm	150x0.150mm
PLC-0515-SCX1K5 \$400	PLC-1015-SCX1K5 \$400	PLC-1515-SCX1K5 \$400

POLYMERIC SCX 4000Å 5µm

50x0.075mm	100x0.075mm	150x0.075mm
PLC-0507-SCX4K5 \$400	PLC-1007-SCX4K5 \$400	PLC-1507-SCX4K5 \$400
50x0.150mm	100x0.150mm	150x0.150mm
PLC-0515-SCX4K5 \$400	PLC-1015-SCX4K5 \$400	PLC-1515-SCX4K5 \$400

POLYMERIC Weak Anion Exchange Microbore Columns

POLYMERIC WAX 1000Å 5µm

50x0.075mm	100x0.075mm	150x0.075mm
PLC-0507-WAX1K5 \$400	PLC-1007-WAX1K5 \$400	PLC-1507-WAX1K5 \$400
50x0.150mm	100x0.150mm	150x0.150mm
PLC-0515-WAX1K5 \$400	PLC-1015-WAX1K5 \$400	PLC-1515-WAX1K5 \$400

POLYMERIC WAX 4000Å 5µm

50x0.075mm	100x0.075mm	150x0.075mm
PLC-0507-WAX4K5 \$400	PLC-1007-WAX4K5 \$400	PLC-1507-WAX4K5 \$400
50x0.150mm	100x0.150mm	150x0.150mm
PLC-0515-WAX4K5 \$400	PLC-1015-WAX4K5 \$400	PLC-1515-WAX4K5 \$400

POLYMERIC Weak Cation Exchange Microbore Columns

POLYMERIC WCX 1000Å 5µm

50x0.075mm	100x0.075mm	150x0.075mm
PLC-0507-WCX1K5 \$400	PLC-1007-WCX1K5 \$400	PLC-1507-WCX1K5 \$400
50x0.150mm	100x0.150mm	150x0.150mm
PLC-0515-WCX1K5 \$400	PLC-1015-WCX1K5 \$400	PLC-1515-WCX1K5 \$400

POLYMERIC WCX 4000Å 5µm

50x0.075mm	100x0.075mm	150x0.075mm
PLC-0507-WCX4K5 \$400	PLC-1007-WCX4K5 \$400	PLC-1507-WCX4K5 \$400
50x0.150mm	100x0.150mm	150x0.150mm
PLC-0515-WCX4K5 \$400	PLC-1015-WCX4K5 \$400	PLC-1515-WCX4K5 \$400



SPRITE

DIRECT CONNECT HPLC COLUMN



Guide to SPRITE Part Numbers

- xR-0121-xxxx 10 x 2.1mm Sprite
- xR-0221-xxxx 20 x 2.1mm Sprite
- xR-0421-xxxx 40 x 2.1mm Sprite

See Page 23 for complete Part Number information

The Sprite family of narrowbore HPLC columns is a unique high performance product for LC-MS and other high-speed, small volume applications. All three sizes of 2.1mm I.D Sprite HPLC columns are individually tested. A Certificate of Analysis accompanies each column. The Sprite's certificate includes the original chromatogram and comprehensive testing and sorbent documentation.

The inert PEEK and titanium design has been proven to be structurally sound to over 5,000 PSI (340Bar).

The optional Higgins *Micro Column Connection Kit* (P/N MIC-KIT, see page 74) includes sleeves and finger-tight bushings to facilitate the attachment of a Sprite to most injection valves, detectors, and MS source inlets.

CLIQUEUS Sprite



CLIQUEUS C8 5µm

10X2.1mm	20X2.1mm	40X2.1mm
CR-0121-C085 \$175	CR-0221-C085 \$185	CR-0421-C085 \$215

CLIQUEUS C18 5µm

10X2.1mm	20X2.1mm	40X2.1mm
CR-0121-C185 \$175	CR-0221-C185 \$185	CR-0421-C185 \$215

CLIQUEUS Cyano 5µm

10X2.1mm	20X2.1mm	40X2.1mm
CR-0121-CNP5 \$175	CR-0221-CNP5 \$185	CR-0421-CNP5 \$215

CLIQUEUS Phenyl 5µm

10X2.1mm	20X2.1mm	40X2.1mm
CR-0121-PHN5 \$175	CR-0221-PHN5 \$185	CR-0421-PHN5 \$215

CLIQUEUS Silica 5µm

10X2.1mm	20X2.1mm	40X2.1mm
CR-0121-SIL5 \$175	CR-0221-SIL5 \$185	CR-0421-SIL5 \$215

HAISIL 100 Sprite



HAISIL 100 C8 5µm

10X2.1mm	20X2.1mm	40X2.1mm
HR-0121-M085 \$175	HR-0221-M085 \$185	HR-0421-M085 \$215

HAISIL 100 C18 5µm

10X2.1mm	20X2.1mm	40X2.1mm
HR-0121-M185 \$175	HR-0221-M185 \$185	HR-0421-M185 \$215

HAISIL 300 Sprite



HAISIL 300 C18 5µm

10X2.1mm	20X2.1mm	40X2.1mm
HR-0121-W185 \$175	HR-0221-W185 \$185	HR-0421-W185 \$215



HAISIL HL Sprite



HAISIL HL C18 5µm

10X2.1mm LR-0121-C185	\$175	20X2.1mm LR-0221-C185	\$185	40X2.1mm LR-0421-C185	\$215
--------------------------	-------	--------------------------	-------	--------------------------	-------

HEAVY Sprite



HEAVY C18 5µm

10X2.1mm VR-0121-C185	\$175	20X2.1mm VR-0221-C185	\$185	40X2.1mm VR-0421-C185	\$215
--------------------------	-------	--------------------------	-------	--------------------------	-------

PHALANX Sprite



PHALANX C18 5µm

10X2.1mm PR-0121-C185	\$175	20X2.1mm PR-0221-C185	\$185	40X2.1mm PR-0421-C185	\$215
--------------------------	-------	--------------------------	-------	--------------------------	-------

PROTO 200 Sprite

200

PROTO 200 C4 5µm

10X2.1mm RR-0121-D045	\$175	20X2.1mm RR-0221-D045	\$185	40X2.1mm RR-0421-D045	\$215
--------------------------	-------	--------------------------	-------	--------------------------	-------

PROTO 200 C18 5µm

10X2.1mm RR-0121-D185	\$175	20X2.1mm RR-0221-D185	\$185	40X2.1mm RR-0421-D185	\$215
--------------------------	-------	--------------------------	-------	--------------------------	-------

PROTO 300 Sprite



PROTO 300 C4 5µm

10X2.1mm RR-0121-W045	\$175	20X2.1mm RR-0221-W045	\$185	40X2.1mm RR-0421-W045	\$215
--------------------------	-------	--------------------------	-------	--------------------------	-------

PROTO 300 C18 5µm

10X2.1mm RR-0121-W185	\$175	20X2.1mm RR-0221-W185	\$185	40X2.1mm RR-0421-W185	\$215
--------------------------	-------	--------------------------	-------	--------------------------	-------

TARGA Sprite



TARGA C8 5µm

10X2.1mm TR-0121-C085	\$175	20X2.1mm TR-0221-C085	\$185	40X2.1mm TR-0421-C085	\$215
--------------------------	-------	--------------------------	-------	--------------------------	-------

TARGA C18 5µm

10X2.1mm TR-0121-C185	\$175	20X2.1mm TR-0221-C185	\$185	40X2.1mm TR-0421-C185	\$215
--------------------------	-------	--------------------------	-------	--------------------------	-------



SPRITE is Designed to Operate in Either Flow Direction

A SPRITE is made of PEEK and titanium and can be connected directly to a sample injection valve or directly to a mass spectrometer's source inlet.



SPRITE (continued)

DIRECT CONNECT HPLC COLUMN



POLYMERIC Reverse Phase Sprite

POLYMERIC PLRP-S 100Å 3µm

10X2.1mm PLR-0121-RP13	\$175	20X2.1mm PLR-0221-RP13	\$185	40X2.1mm PLR-0421-RP13	\$215
---------------------------	-------	---------------------------	-------	---------------------------	-------

POLYMERIC PLRP-S 300Å 3µm

10X2.1mm PLR-0121-RP33	\$175	20X2.1mm PLR-0221-RP33	\$185	40X2.1mm PLR-0421-RP33	\$215
---------------------------	-------	---------------------------	-------	---------------------------	-------

POLYMERIC PLRP-S 1000Å 5µm

10X2.1mm PLR-0121-RP1K5	\$175	20X2.1mm PLR-0221-RP1K5	\$185	40X2.1mm PLR-0421-RP1K5	\$215
----------------------------	-------	----------------------------	-------	----------------------------	-------

POLYMERIC PLRP-S 4000Å 5µm

10X2.1mm PLR-0121-RP4K5	\$175	20X2.1mm PLR-0221-RP4K5	\$185	40X2.1mm PLR-0421-RP4K5	\$215
----------------------------	-------	----------------------------	-------	----------------------------	-------

POLYMERIC Strong Anion Exchange Sprite

POLYMERIC SAX 1000Å 5µm

10X2.1mm PLR-0121-AX1K5	\$175	20X2.1mm PLR-0221-AX1K5	\$185	40X2.1mm PLR-0421-AX1K5	\$215
----------------------------	-------	----------------------------	-------	----------------------------	-------

POLYMERIC SAX 4000Å 5µm

10X2.1mm PLR-0121-AX4K5	\$175	20X2.1mm PLR-0221-AX4K5	\$185	40X2.1mm PLR-0421-AX4K5	\$215
----------------------------	-------	----------------------------	-------	----------------------------	-------

POLYMERIC Strong Cation Exchange Sprite

POLYMERIC SCX 1000Å 5µm

10X2.1mm PLR-0121-SCX1K5	\$175	20X2.1mm PLR-0221-SCX1K5	\$185	40X2.1mm PLR-0421-SCX1K5	\$215
-----------------------------	-------	-----------------------------	-------	-----------------------------	-------

POLYMERIC SCX 4000Å 5µm

10X2.1mm PLR-0121-SCX4K5	\$175	20X2.1mm PLR-0221-SCX4K5	\$185	40X2.1mm PLR-0421-SCX4K5	\$215
-----------------------------	-------	-----------------------------	-------	-----------------------------	-------

POLYMERIC Weak Anion Exchange Sprite

POLYMERIC WAX 1000Å 5µm

10X2.1mm PLR-0121-WAX1K5	\$175	20X2.1mm PLR-0221-WAX1K5	\$185	40X2.1mm PLR-0421-WAX1K5	\$215
-----------------------------	-------	-----------------------------	-------	-----------------------------	-------

POLYMERIC WAX 4000Å 5µm

10X2.1mm PLR-0121-WAX4K5	\$175	20X2.1mm PLR-0221-WAX4K5	\$185	40X2.1mm PLR-0421-WAX4K5	\$215
-----------------------------	-------	-----------------------------	-------	-----------------------------	-------

POLYMERIC Weak Cation Exchange Sprite

POLYMERIC WCX 1000Å 5µm

10X2.1mm PLR-0121-WCX1K5	\$175	20X2.1mm PLR-0221-WCX1K5	\$185	40X2.1mm PLR-0421-WCX1K5	\$215
-----------------------------	-------	-----------------------------	-------	-----------------------------	-------

POLYMERIC WCX 4000Å 5µm

10X2.1mm PLR-0121-WCX4K5	\$175	20X2.1mm PLR-0221-WCX4K5	\$185	40X2.1mm PLR-0421-WCX4K5	\$215
-----------------------------	-------	-----------------------------	-------	-----------------------------	-------



PICCOLO

SHORT MICROBORE TRAPS AND COLUMNS



The Piccolo family of microbore HPLC columns is a unique high performance product for LC-MS and other high-speed, small volume applications. These efficient columns are the only products of their type that are individually tested. A Certificate of Analysis accompanies each column.

In addition to analytical microbore applications Piccolo columns are ideal guards for protecting longer microbore HPLC columns.

Piccolo column void volumes range from approximately 5µl to 300nL, making them perfect for a wide variety of trapping, desalting, and trace enrichment applications. These small columns can be conveniently used with micro injection and switching valves as pictured on the left.

The optional Higgins *Micro Column Connection Kit* (P/N MIC-KIT, see page 74) includes sleeves and finger-tight bushings to facilitate the attachment of a Piccolo to most injection valves, detectors, and MS source inlets.

Guide to PICCOLO Part Numbers

- xP-M2M3-xxxx 2.5 x 0.3mm PICCOLO
- xP-M2M5-xxxx 2.5 x 0.5mm PICCOLO
- xP-M501-xxxx 5 x 1mm PICCOLO
- xP-0101-xxxx 10 x 1mm PICCOLO
- xP-0301-xxxx 30 x 1mm PICCOLO

NEW

See Page 23 for complete Part Number information

CLIQUEUS Piccolo



CLIQUEUS C8 5µm

2.5X0.3mm	2.5X0.5mm	5X1mm	10x1mm	30x1mm
CP-M2M3-C085 \$175	CP-M2M5-C085 \$175	CP-M501-C085 \$175	CP-0101-C085 \$175	CP-0301-C085 \$220

CLIQUEUS C18 5µm

2.5X0.3mm	2.5X0.5mm	5X1mm	10x1mm	30x1mm
CP-M2M3-C185 \$175	CP-M2M5-C185 \$175	CP-M501-C185 \$175	CP-0101-C185 \$175	CP-0301-C185 \$220

CLIQUEUS Cyano 5µm

2.5X0.3mm	2.5X0.5mm	5X1mm	10x1mm	30x1mm
CP-M2M3-CNP5 \$175	CP-M2M5-CNP5 \$175	CP-M501-CNP5 \$175	CP-0101-CNP5 \$175	CP-0301-CNP5 \$220

CLIQUEUS Phenyl 5µm

2.5X0.3mm	2.5X0.5mm	5X1mm	10x1mm	30x1mm
CP-M2M3-PHN5 \$175	CP-M2M5-PHN5 \$175	CP-M501-PHN5 \$175	CP-0101-PHN5 \$175	CP-0301-PHN5 \$220

CLIQUEUS Silica 5µm

2.5X0.3mm	2.5X0.5mm	5X1mm	10x1mm	30x1mm
CP-M2M3-SIL5 \$175	CP-M2M5-SIL5 \$175	CP-M501-SIL5 \$175	CP-0101-SIL5 \$175	CP-0301-SIL5 \$220

HAISIL 100 Piccolo



HAISIL 100 C8 5µm

2.5X0.3mm	2.5X0.5mm	5X1mm	10x1mm	30x1mm
HP-M2M3-M085 \$175	HP-M2M5-M085 \$175	HP-M501-M085 \$175	HP-0101-M085 \$175	CP-0301-M085 \$220

HAISIL 100 C18 5µm

2.5X0.3mm	2.5X0.5mm	5X1mm	10x1mm	30x1mm
HP-M2M3-M185 \$175	HP-M2M5-M185 \$175	HP-M501-M185 \$175	HP-0101-M185 \$175	CP-0301-M185 \$220

HAISIL 300 Piccolo



HAISIL 300 C18 5µm

2.5X0.3mm	2.5X0.5mm	5X1mm	10x1mm	30x1mm
HP-M2M3-W185 \$175	HP-M2M5-W185 \$175	HP-M501-W185 \$175	HP-0101-W185 \$175	CP-0301-W185 \$220



PICCOLO (continued)

SHORT MICROBORE COLUMNS



NEW
30x1mm
For 3 times greater
trapping capacity

HAISIL HL Piccolo

HAISIL HL C18 5µm

2.5X0.3mm LP-M2M3-C185	\$175	2.5X0.5mm LP-M2M5-C185	\$175	5X1mm LP-M501-C185	\$175	10x1mm LP-0101-C185	\$175	30x1mm LP-0301-C185	\$220
---------------------------	-------	---------------------------	-------	-----------------------	-------	------------------------	-------	------------------------	-------

HEAVY Piccolo

HEAVY C18 5µm

2.5X0.3mm VP-M2M3-C185	\$175	2.5X0.5mm VP-M2M5-C185	\$175	5X1mm VP-M501-C185	\$175	10x1mm VP-0101-C185	\$175	30x1mm VP-0301-C185	\$220
---------------------------	-------	---------------------------	-------	-----------------------	-------	------------------------	-------	------------------------	-------

PHALANX Piccolo

PHALANX C18 5µm

2.5X0.3mm PP-M2M3-C185	\$175	2.5X0.5mm PP-M2M5-C185	\$175	5X1mm PP-M501-C185	\$175	10x1mm PP-0101-C185	\$175	30x1mm PP-0301-C185	\$220
---------------------------	-------	---------------------------	-------	-----------------------	-------	------------------------	-------	------------------------	-------

PROTO 200 Piccolo 200

PROTO 200 C4 5µm

2.5X0.3mm RP-M2M3-D045	\$175	2.5X0.5mm RP-M2M5-D045	\$175	5X1mm RP-M501-D045	\$175	10x1mm RP-0101-D045	\$175	30x1mm RP-0301-D045	\$220
---------------------------	-------	---------------------------	-------	-----------------------	-------	------------------------	-------	------------------------	-------

PROTO 200 C18 5µm

2.5X0.3mm RP-M2M3-D185	\$175	2.5X0.5mm RP-M2M5-D185	\$175	5X1mm RP-M501-D185	\$175	10x1mm RP-0101-D185	\$175	30x1mm RP-0301-D185	\$220
---------------------------	-------	---------------------------	-------	-----------------------	-------	------------------------	-------	------------------------	-------

PROTO 300 Piccolo

PROTO 300 C4 5µm

2.5X0.3mm RP-M2M3-W045	\$175	2.5X0.5mm RP-M2M5-W045	\$175	5X1mm RP-M501-W045	\$175	10x1mm RP-0101-W045	\$175	30x1mm RP-0301-W045	\$220
---------------------------	-------	---------------------------	-------	-----------------------	-------	------------------------	-------	------------------------	-------

PROTO 300 C18 5µm

2.5X0.3mm RP-M2M3-W185	\$175	2.5X0.5mm RP-M2M5-W185	\$175	5X1mm RP-M501-W185	\$175	10x1mm RP-0101-W185	\$175	30x1mm RP-0301-W185	\$220
---------------------------	-------	---------------------------	-------	-----------------------	-------	------------------------	-------	------------------------	-------

TARGA Piccolo

TARGA C8 5µm

2.5X0.3mm TP-M2M3-C085	\$175	2.5X0.5mm TP-M2M5-C085	\$175	5X1mm TP-M501-C085	\$175	10x1mm TP-0101-C085	\$175	30x1mm TP-0301-C085	\$220
---------------------------	-------	---------------------------	-------	-----------------------	-------	------------------------	-------	------------------------	-------

TARGA C18 5µm

2.5X0.3mm TP-M2M3-C185	\$175	2.5X0.5mm TP-M2M5-C185	\$175	5X1mm TP-M501-C185	\$175	10x1mm TP-0101-C185	\$175	30x1mm TP-0301-C185	\$220
---------------------------	-------	---------------------------	-------	-----------------------	-------	------------------------	-------	------------------------	-------



NEW

POLYMERIC Reverse Phase Piccolo

POLYMERIC PLRP-S 100Å 3µm

2.5X0.3mm	2.5X0.5mm	5X1mm	10x1mm	30x1mm
PLP-M2M3-RP13 \$175	PLP-M2M5-RP13 \$175	PLP-M501-RP13 \$175	PLP-0101-RP13 \$175	PLP-0301-RP13 \$220

POLYMERIC PLRP-S 300Å 3µm

2.5X0.3mm	2.5X0.5mm	5X1mm	10x1mm	30x1mm
PLP-M2M3-RP33 \$175	PLP-M2M5-RP33 \$175	PLP-M501-RP33 \$175	PLP-0101-RP33 \$175	PLP-0301-RP33 \$220

POLYMERIC PLRP-S 1000Å 5µm

2.5X0.3mm	2.5X0.5mm	5X1mm	10x1mm	30x1mm
PLP-M2M3-RP1K5 \$175	PLP-M2M5-RP1K5 \$175	PLP-M501-RP1K5 \$175	PLP-0101-RP1K5 \$175	PLP-0301-RP1K5 \$220

POLYMERIC PLRP-S 4000Å 5µm

2.5X0.3mm	2.5X0.5mm	5X1mm	10x1mm	30x1mm
PLP-M2M3-RP4K5 \$175	PLP-M2M5-RP4K5 \$175	PLP-M501-RP4K5 \$175	PLP-0101-RP4K5 \$175	PLP-0301-RP4K5 \$220

POLYMERIC Strong Anion Exchange Piccolo

POLYMERIC SAX 1000Å 5µm

2.5X0.3mm	2.5X0.5mm	5X1mm	10x1mm	30x1mm
PLP-M2M3-AX1K5 \$175	PLP-M2M5-AX1K5 \$175	PLP-M501-AX1K5 \$175	PLP-0101-AX1K5 \$175	PLP-0301-AX1K5 \$220

POLYMERIC SAX 4000Å 5µm

2.5X0.3mm	2.5X0.5mm	5X1mm	10x1mm	30x1mm
PLP-M2M3-AX4K5 \$175	PLP-M2M5-AX4K5 \$175	PLP-M501-AX4K5 \$175	PLP-0101-AX4K5 \$175	PLP-0301-AX4K5 \$220

POLYMERIC Strong Cation Exchange Piccolo

POLYMERIC SCX 1000Å 5µm

2.5X0.3mm	2.5X0.5mm	5X1mm	10x1mm	30x1mm
PLP-M2M3-SCX1K5 \$175	PLP-M2M5-SCX1K5 \$175	PLP-M501-SCX1K5 \$175	PLP-0101-SCX1K5 \$175	PLP-0301-SCX1K5 \$220

POLYMERIC SCX 4000Å 5µm

2.5X0.3mm	2.5X0.5mm	5X1mm	10x1mm	30x1mm
PLP-M2M3-SCX4K5 \$175	PLP-M2M5-SCX4K5 \$175	PLP-M501-SCX4K5 \$175	PLP-0101-SCX4K5 \$175	PLP-0301-SCX4K5 \$220

POLYMERIC Weak Anion Exchange Piccolo

POLYMERIC WAX 1000Å 5µm

2.5X0.3mm	2.5X0.5mm	5X1mm	10x1mm	30x1mm
PLP-M2M3-WAX1K5 \$175	PLP-M2M5-WAX1K5 \$175	PLP-M501-WAX1K5 \$175	PLP-0101-WAX1K5 \$175	PLP-0301-WAX1K5 \$220

POLYMERIC WAX 4000Å 5µm

2.5X0.3mm	2.5X0.5mm	5X1mm	10x1mm	30x1mm
PLP-M2M3-WAX4K5 \$175	PLP-M2M5-WAX4K5 \$175	PLP-M501-WAX4K5 \$175	PLP-0101-WAX4K5 \$175	PLP-0301-WAX4K5 \$220

POLYMERIC Weak Cation Exchange Piccolo

POLYMERIC WCX 1000Å 5µm

2.5X0.3mm	2.5X0.5mm	5X1mm	10x1mm	30x1mm
PLP-M2M3-WCX1K5 \$175	PLP-M2M5-WCX1K5 \$175	PLP-M501-WCX1K5 \$175	PLP-0101-WCX1K5 \$175	PLP-0301-WCX1K5 \$220

POLYMERIC WCX 4000Å 5µm

2.5X0.3mm	2.5X0.5mm	5X1mm	10x1mm	30x1mm
PLP-M2M3-WCX4K5 \$175	PLP-M2M5-WCX4K5 \$175	PLP-M501-WCX4K5 \$175	PLP-0101-WCX4K5 \$175	PLP-0301-WCX4K5 \$220



HAICART CARTRIDGES

STAINLESS STEEL CARTRIDGE COLUMNS



Guide to HAICART Analytical Cartridge Part Numbers

xF-0421-xxxx	40 x 3.2mm stainless steel cartridge
xF-0532-xxxx	50 x 3.2mm stainless steel cartridge
xF-1032-xxxx	100 x 3.2mm stainless steel cartridge
xF-0446-xxxx	40 x 4.6mm stainless steel cartridge
xF-0546-xxxx	50 x 4.6mm stainless steel cartridge
xF-1046-xxxx	100 x 4.6mm stainless steel cartridge

See Page 23 for complete Part Number information

The HAICART family of HPLC cartridge columns provides a convenient and economical approach to guard column, trace enrichment, and fast analysis applications. These stainless steel cartridges are available with 3.2mm and 4.6mm internal diameters and with 2, 4, 5, or 10cm lengths. This wide selection makes it possible to address numerous analytical needs.

See pages 72 - 73 for information about the cartridge holders required for Higgins Analytical's HAICART Cartridge Columns. HAICART cartridges are also compatible with PE/Brownlee MPLC cartridge holders.

CLIQUEUS 3.2 and 4.6mm I.D. S.S. Cartridges



CLIQUEUS C8 5µm

20X3.2mm	5/pkg	40X3.2mm	2/pkg	50X3.2mm	2/pkg	100X3.2mm	1/pkg
CF-0232-C085	\$175	CF-0432-C085	\$290	CF-0532-C085	\$305	CF-1032-C085	\$205
		40X4.6mm	2/pkg	50X4.6mm	2/pkg	100X4.6mm	1/pkg
		CF-0446-C085	\$290	CF-0546-C085	\$305	CF-1046-C085	\$205

CLIQUEUS C18 5µm

20X3.2mm	5/pkg	40X3.2mm	2/pkg	50X3.2mm	2/pkg	100X3.2mm	1/pkg
CF-0232-C185	\$175	CF-0432-C185	\$290	CF-0532-C185	\$305	CF-1032-C185	\$205
		40X4.6mm	2/pkg	50X4.6mm	2/pkg	100X4.6mm	1/pkg
		CF-0446-C185	\$290	CF-0546-C185	\$305	CF-1046-C185	\$205

CLIQUEUS Cyano 5µm

20X3.2mm	5/pkg	40X3.2mm	2/pkg	50X3.2mm	2/pkg	100X3.2mm	1/pkg
CF-0232-CNP5	\$185	CF-0432-CNP5	\$305	CF-0532-CNP5	\$320	CF-1032-CNP5	\$215
		40X4.6mm	2/pkg	50X4.6mm	2/pkg	100X4.6mm	1/pkg
		CF-0446-CNP5	\$305	CF-0546-CNP5	\$320	CF-1046-CNP5	\$215

CLIQUEUS Phenyl 5µm

20X3.2mm	5/pkg	40X3.2mm	2/pkg	50X3.2mm	2/pkg	100X3.2mm	1/pkg
CF-0232-PHN5	\$185	CF-0432-PHN5	\$305	CF-0532-PHN5	\$320	CF-1032-PHN5	\$215
		40X4.6mm	2/pkg	50X4.6mm	2/pkg	100X4.6mm	1/pkg
		CF-0446-PHN5	\$305	CF-0546-PHN5	\$320	CF-1046-PHN5	\$215

CLIQUEUS Silica 5µm

20X3.2mm	5/pkg	40X3.2mm	2/pkg	50X3.2mm	2/pkg	100X3.2mm	1/pkg
CF-0232-SIL5	\$175	CF-0432-SIL5	\$290	CF-0532-SIL5	\$305	CF-1032-SIL5	\$205
		40X4.6mm	2/pkg	50X4.6mm	2/pkg	100X4.6mm	1/pkg
		CF-0446-SIL5	\$290	CF-0546-SIL5	\$305	CF-1046-SIL5	\$205

HAISIL 100 C8 3.2 and 4.6mm I.D. S.S. Cartridges



HAISIL 100 C8 5µm

20X3.2mm	5/pkg	40X3.2mm	2/pkg	50X3.2mm	2/pkg	100X3.2mm	1/pkg
HF-0232-M085	\$155	HF-0432-M085	\$260	HF-0532-M085	\$265	HF-1032-M085	\$180
		40X4.6mm	2/pkg	50X4.6mm	2/pkg	100X4.6mm	1/pkg
		HF-0446-M085	\$260	HF-0546-M085	\$265	HF-1046-M085	\$180



HAISIL 100 C18 3.2 and 4.6mm I.D. S.S.Cartridges 

HAISIL 100 C18 5µm

20X3.2mm	5/pkg	40X3.2mm	2/pkg	50X3.2mm	2/pkg	100X3.2mm	1/pkg
HF-0232-M185	\$155	HF-0432-M185	\$260	HF-0532-M185	\$265	HF-1032-M185	\$180
		40X4.6mm	2/pkg	50X4.6mm	2/pkg	100X4.6mm	1/pkg
		HF-0446-M185	\$260	HF-0546-M185	\$265	HF-1046-M185	\$180

HAISIL 300 3.2 and 4.6mm I.D. S.S.Cartridges 

HAISIL 300 C18 5µm

20X3.2mm	5/pkg	40X3.2mm	2/pkg	50X3.2mm	2/pkg	100X3.2mm	1/pkg
HF-0232-W185	\$190	HF-0432-W185	\$330	HF-0532-W185	\$340	HF-1032-W185	\$225
		40X4.6mm	2/pkg	50X4.6mm	2/pkg	100X4.6mm	1/pkg
		HF-0446-W185	\$330	HF-0546-W185	\$340	HF-1046-W185	\$225

HAISIL HL 3.2 and 4.6mm I.D. S.S.Cartridges 

HAISIL HL C18 5µm

20X3.2mm	5/pkg	40X3.2mm	2/pkg	50X3.2mm	2/pkg	100X3.2mm	1/pkg
LF-0232-C185	\$185	LF-0432-C185	\$330	LF-0532-C185	\$340	LF-1032-C185	\$225
		40X4.6mm	2/pkg	50X4.6mm	2/pkg	100X4.6mm	1/pkg
		LF-0446-C185	\$330	LF-0546-C185	\$340	LF-1046-C185	\$225

HEAVY 3.2 and 4.6mm I.D. S.S.Cartridges 

HEAVY C18 5µm

20X3.2mm	5/pkg	40X3.2mm	2/pkg	50X3.2mm	2/pkg	100X3.2mm	1/pkg
VF-0232-C185	\$190	VF-0432-C185	\$330	VF-0532-C185	\$340	VF-1032-C185	\$225
		40X4.6mm	2/pkg	50X4.6mm	2/pkg	100X4.6mm	1/pkg
		VF-0446-C185	\$330	VF-0546-C185	\$340	VF-1046-C185	\$225

PHALANX 3.2 and 4.6mm I.D. S.S.Cartridges 

PHALANX C18 5µm

20X3.2mm	5/pkg	40X3.2mm	2/pkg	50X3.2mm	2/pkg	100X3.2mm	1/pkg
PF-0232-C185	\$190	PF-0432-C185	\$330	PF-0532-C185	\$340	PF-1032-C185	\$225
		40X4.6mm	2/pkg	50X4.6mm	2/pkg	100X4.6mm	1/pkg
		PF-0446-C185	\$330	PF-0546-C185	\$340	PF-1046-C185	\$225

PROTO 200 3.2 and 4.6mm I.D. S.S.Cartridges 

PROTO 200 C4 5µm

20X3.2mm	5/pkg	40X3.2mm	2/pkg	50X3.2mm	2/pkg	100X3.2mm	1/pkg
RF-0232-D045	\$190	RF-0432-D045	\$330	RF-0532-D045	\$340	RF-1032-D045	\$225
		40X4.6mm	2/pkg	50X4.6mm	2/pkg	100X4.6mm	1/pkg
		RF-0446-D045	\$330	RF-0546-D045	\$340	RF-1046-D045	\$225

PROTO 200 C18 5µm

20X3.2mm	5/pkg	40X3.2mm	2/pkg	50X3.2mm	2/pkg	100X3.2mm	1/pkg
RF-0232-D185	\$190	RF-0432-D185	\$330	RF-0532-D185	\$340	RF-1032-D185	\$225
		40X4.6mm	2/pkg	50X4.6mm	2/pkg	100X4.6mm	1/pkg
		RF-0446-D185	\$330	RF-0546-D185	\$340	RF-1046-D185	\$225

PROTO 300 3.2 and 4.6mm I.D. S.S.Cartridges 

PROTO 300 C4 5µm

20X3.2mm	5/pkg	40X3.2mm	2/pkg	50X3.2mm	2/pkg	100X3.2mm	1/pkg
RF-0232-W045	\$190	RF-0432-W045	\$330	RF-0532-W045	\$340	RF-1032-W045	\$225
		40X4.6mm	2/pkg	50X4.6mm	2/pkg	100X4.6mm	1/pkg
		RF-0446-W045	\$330	RF-0546-W045	\$340	RF-1046-W045	\$225

PROTO 300 C18 5µm

20X3.2mm	5/pkg	40X3.2mm	2/pkg	50X3.2mm	2/pkg	100X3.2mm	1/pkg
RF-0232-W185	\$190	RF-0432-W185	\$330	RF-0532-W185	\$340	RF-1032-W185	\$225
		40X4.6mm	2/pkg	50X4.6mm	2/pkg	100X4.6mm	1/pkg
		RF-0446-W185	\$330	RF-0546-W185	\$340	RF-1046-W185	\$225



HAICART CARTRIDGES (continued)

STAINLESS STEEL CARTRIDGE COLUMNS



TARGA 3.2 and 4.6mm I.D. S.S. Cartridges



TARGA C8 5µm

20X3.2mm TF-0232-C085	5/pkg \$175	40X3.2mm TF-0432-C085	2/pkg \$330	50X3.2mm TF-0532-C085	2/pkg \$340	100X3.2mm TF-1032-C085	1/pkg \$225
		40X4.6mm TF-0446-C085	2/pkg \$330	50X4.6mm TF-0546-C085	2/pkg \$340	100X4.6mm TF-1046-C085	1/pkg \$225

TARGA C18 5µm

20X3.2mm TF-0232-C185	5/pkg \$175	40X3.2mm TF-0432-C185	2/pkg \$330	50X3.2mm TF-0532-C185	2/pkg \$340	100X3.2mm TF-1032-C185	1/pkg \$225
		40X4.6mm TF-0446-C185	2/pkg \$330	50X4.6mm TF-0546-C185	2/pkg \$340	100X4.6mm TF-1046-C185	1/pkg \$225



See pages 72 - 73 for information about the Cartridge Holders required for these Cartridges



POLYMERIC Reverse Phase 3.2 I.D. S.S.Cartridges

POLYMERIC PLRP-S 4000Å 5µm

20X3.2mm 5/pkg
PLF-0232-RP4K5 \$225

POLYMERIC Strong Anion Exchange 3.2 I.D. S.S.Cartridges

POLYMERIC SAX 1000Å 5µm

20X3.2mm 5/pkg
PLF-0232-AX1K5 \$225

POLYMERIC SAX 4000Å 5µm

20X3.2mm 5/pkg
PLF-0232-AX4K5 \$225

POLYMERIC Strong Cation Exchange 3.2 I.D. S.S.Cartridges

POLYMERIC SCX 1000Å 5µm

20X3.2mm 5/pkg
PLF-0232-SCX1K5 \$225

POLYMERIC SCX 4000Å 5µm

20X3.2mm 5/pkg
PLF-0232-SCX4K5 \$225

POLYMERIC Weak Anion Exchange 3.2 I.D. S.S.Cartridges

POLYMERIC WAX 1000Å 5µm

20X3.2mm 5/pkg
PLF-0232-WAX1K5 \$225

POLYMERIC WAX 4000Å 5µm

20X3.2mm 5/pkg
PLF-0221-WAX4K5 \$225

POLYMERIC Weak Cation Exchange 3.2 I.D. S.S.Cartridges

POLYMERIC WCX 1000Å 5µm

20X3.2mm 5/pkg
PLF-0232-WCX1K5 \$225

POLYMERIC WCX 4000Å 5µm

20X3.2mm 5/pkg
PLF-0232-WCX4K5 \$225



HAIPEEK CARTRIDGES

PEEK/TITANIUM CARTRIDGE COLUMNS



Guide to HAIPEEK Analytical Cartridge Part Numbers

xK-0421-xxxx 40 x 2.1mm PEEK/titanium cartridge
 xK-0521-xxxx 50 x 2.1mm PEEK/titanium cartridge

See Page 23 for complete Part Number information

PEEK and Titanium Cartridges

The HAIPEEK family of narrowbore HPLC cartridge columns is a unique high performance product for LC-MS and other high-speed, small volume applications. The 40 and 50mm sizes of 2.1mm I.D HAIPEEK HPLC Cartridges are individually tested. A Certificate of Analysis, which includes the original chromatogram and comprehensive testing and sorbent documentation, accompanies each column. The 20mm x 2.1mm cartridges excel as narrowbore guard columns, yet even though they are not individually tested, the majority are routinely used as very economical and efficient columns for high speed HPLC screening and LC-MS applications. See pages 72 - 73 for information about the cartridge holders required for Higgins Analytical's HAIPEEK Cartridge Columns. HAIPEEK cartridges are also compatible with PE/Brownlee MPLC cartridge holders.

CLIQUEUS 2.1mm I.D. PEEK/Titanium Cartridges



CLIQUEUS C8 5µm

20X2.1mm	5/pkg	40X2.1mm	2/pkg	50X2.1mm	2/pkg
CK-0221-C085	\$180	CK-0421-C085	\$270	CK-0521-C085	\$275

CLIQUEUS C18 5µm

20X2.1mm	5/pkg	40X2.1mm	2/pkg	50X2.1mm	2/pkg
CK-0221-C185	\$180	CK-0421-C185	\$270	CK-0521-C185	\$275

CLIQUEUS Cyano 5µm

20X2.1mm	5/pkg	40X2.1mm	2/pkg	50X2.1mm	2/pkg
CK-0221-CNP5	\$190	CK-0421-CNP5	\$285	CK-0521-CNP5	\$290

CLIQUEUS Phenyl 5µm

20X2.1mm	5/pkg	40X2.1mm	2/pkg	50X2.1mm	2/pkg
CK-0221-PHN5	\$190	CK-0421-PHN5	\$285	CK-0521-PHN5	\$290

CLIQUEUS Silica 5µm

20X2.1mm	5/pkg	40X2.1mm	2/pkg	50X2.1mm	2/pkg
CK-0221-SIL5	\$180	CK-0421-SIL5	\$270	CK-0521-SIL5	\$275

HASIL 100 2.1mm I.D. PEEK/Titanium Cartridges



HASIL 100 C8 5µm

20X2.1mm	5/pkg	40X2.1mm	2/pkg	50X2.1mm	2/pkg
HK-0221-M085	\$160	HK-0421-M085	\$235	HK-0521-M085	\$240

HASIL 100 C18 5µm

20X2.1mm	5/pkg	40X2.1mm	2/pkg	50X2.1mm	2/pkg
HK-0221-M185	\$160	HK-0421-M185	\$235	HK-0521-M185	\$240



See pages 72 - 73 for information about the Cartridge Holders required for these Cartridges

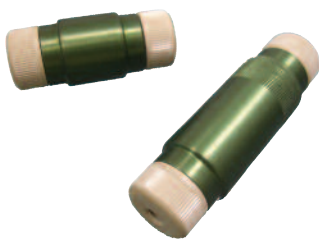

HASIL 300 2.1mm I.D. PEEK/Titanium Cartridges



HASIL 300 C18 5µm

20X2.1mm HK-0221-W185	5/pkg \$190	40X2.1mm HK-0421-W185	2/pkg \$310	50X2.1mm HK-0521-W185	2/pkg \$315
--------------------------	----------------	--------------------------	----------------	--------------------------	----------------

HASIL HL 2.1mm I.D. PEEK/Titanium Cartridges



HASIL HL C18 5µm

20X2.1mm LK-0221-C185	5/pkg \$190	40X2.1mm LK-0421-C185	2/pkg \$300	50X2.1mm LK-0521-C185	2/pkg \$310
--------------------------	----------------	--------------------------	----------------	--------------------------	----------------

HEAVY 2.1mm I.D. PEEK/Titanium Cartridges



HEAVY C18 5µm

20X2.1mm VK-0221-C185	5/pkg \$190	40X2.1mm VK-0421-C185	2/pkg \$310	50X2.1mm VK-0521-C185	2/pkg \$315
--------------------------	----------------	--------------------------	----------------	--------------------------	----------------

PHALANX 2.1mm I.D. PEEK/Titanium Cartridges



PHALANX C18 5µm

20X2.1mm PK-0221-C185	5/pkg \$190	40X2.1mm PK-0421-C185	2/pkg \$310	50X2.1mm PK-0521-C185	2/pkg \$315
--------------------------	----------------	--------------------------	----------------	--------------------------	----------------

PROTO 200 2.1mm I.D. PEEK/Titanium Cartridges

200

PROTO 200 C4 5µm

20X2.1mm RK-0221-D045	5/pkg \$190	40X2.1mm RK-0421-D045	2/pkg \$310	50X2.1mm RK-0521-D045	2/pkg \$315
--------------------------	----------------	--------------------------	----------------	--------------------------	----------------

PROTO 200 C18 5µm

20X2.1mm RK-0221-D185	5/pkg \$190	40X2.1mm RK-0421-D185	2/pkg \$310	50X2.1mm RK-0521-D185	2/pkg \$315
--------------------------	----------------	--------------------------	----------------	--------------------------	----------------

PROTO 300 2.1mm I.D. PEEK/Titanium Cartridges



PROTO 300 C4 5µm

20X2.1mm RK-0221-W045	5/pkg \$190	40X2.1mm RK-0421-W045	2/pkg \$310	50X2.1mm RK-0521-W045	2/pkg \$315
--------------------------	----------------	--------------------------	----------------	--------------------------	----------------

PROTO 300 C18 5µm

20X2.1mm RK-0221-W185	5/pkg \$190	40X2.1mm RK-0421-W185	2/pkg \$310	50X2.1mm RK-0521-W185	2/pkg \$315
--------------------------	----------------	--------------------------	----------------	--------------------------	----------------



HAIPEEK CARTRIDGES (continued)

PEEK/TITANIUM CARTRIDGE COLUMNS



TARGA 2.1mm I.D. PEEK/Titanium Cartridges



TARGA C8 5µm

20X2.1mm	5/pkg	40X2.1mm	2/pkg	50X2.1mm	2/pkg
TK-0221-C085	\$180	TK-0421-C085	\$270	TK-0521-C085	\$280

TARGA C18 5µm

20X2.1mm	5/pkg	40X2.1mm	2/pkg	50X2.1mm	2/pkg
TK-0221-C185	\$180	TK-0421-C185	\$270	TK-0521-C185	\$280

POLYMERIC Reverse Phase 2.1mm I.D. PEEK/Titanium Cartridges

POLYMERIC PLRP-S 100Å 3µm

20X2.1mm	5/pkg	40X2.1mm	2/pkg	50X2.1mm	2/pkg
PLK-0221-RP13	\$225	PLK-0421-RP13	\$320	PLK-0521-RP13	\$335

POLYMERIC PLRP-S 300Å 3µm

20X2.1mm	5/pkg	40X2.1mm	2/pkg	50X2.1mm	2/pkg
PLK-0221-RP33	\$225	PLK-0421-RP33	\$320	PLK-0521-RP33	\$335

POLYMERIC PLRP-S 1000Å 5µm

20X2.1mm	5/pkg	40X2.1mm	2/pkg	50X2.1mm	2/pkg
PLK-0221-RP1K5	\$225	PLK-0421-RP1K5	\$320	PLK-0521-RP1K5	\$335

POLYMERIC PLRP-S 4000Å 5µm

20X2.1mm	5/pkg	40X2.1mm	2/pkg	50X2.1mm	2/pkg
PLK-0221-RP4K5	\$225	PLK-0421-RP4K5	\$320	PLK-0521-RP4K5	\$335

POLYMERIC Strong Anion Exchange 2.1mm I.D. PEEK/Titanium Cartridges

POLYMERIC SAX 1000Å 5µm

20X2.1mm	5/pkg	40X2.1mm	2/pkg	50X2.1mm	2/pkg
PLK-0221-AX1K5	\$225	PLK-0421-AX1K5	\$320	PLK-0521-AX1K5	\$335

POLYMERIC SAX 4000Å 5µm

20X2.1mm	5/pkg	40X2.1mm	2/pkg	50X2.1mm	2/pkg
PLK-0221-AX4K5	\$225	PLK-0421-AX4K5	\$320	PLK-0521-AX4K5	\$335



See pages 72 - 73 for information about the Cartridge Holders required for these Cartridges



POLYMERIC Strong Cation Exchange 2.1mm I.D. PEEK/Titanium Cartridges

POLYMERIC SCX 1000Å 5µm

20X2.1mm	5/pkg	40X2.1mm	2/pkg	50X2.1mm	2/pkg
PLK-0221-SCX1K5	\$225	PLK-0421-SCX1K5	\$320	PLK-0521-SCX1K5	\$335

POLYMERIC SCX 4000Å 5µm

20X2.1mm	5/pkg	40X2.1mm	2/pkg	50X2.1mm	2/pkg
PLK-0221-SCX4K5	\$225	PLK-0421-SCX4K5	\$320	PLK-0521-SCX4K5	\$335

POLYMERIC Weak Anion Exchange 2.1mm I.D. PEEK/Titanium Cartridges

POLYMERIC WAX 1000Å 5µm

20X2.1mm	5/pkg	40X2.1mm	2/pkg	50X2.1mm	2/pkg
PLK-0221-WAX1K5	\$225	PLK-0421-WAX1K5	\$320	PLK-0521-WAX1K5	\$335

POLYMERIC WAX 4000Å 5µm

20X2.1mm	5/pkg	40X2.1mm	2/pkg	50X2.1mm	2/pkg
PLK-0221-WAX4K5	\$225	PLK-0421-WAX4K5	\$320	PLK-0521-WAX4K5	\$335

POLYMERIC Weak Cation Exchange 2.1mm I.D. PEEK/Titanium Cartridges

POLYMERIC WCX 1000Å 5µm

20X2.1mm	5/pkg	40X2.1mm	2/pkg	50X2.1mm	2/pkg
PLK-0221-WCX1K5	\$225	PLK-0421-WCX1K5	\$320	PLK-0521-WCX1K5	\$335

POLYMERIC WCX 4000Å 5µm

20X2.1mm	5/pkg	40X2.1mm	2/pkg	50X2.1mm	2/pkg
PLK-0221-WCX4K5	\$225	PLK-0421-WCX4K5	\$320	PLK-0521-WCX4K5	\$335



HAISpeed 10 CARTRIDGES

10mm I.D. Semi-Prep Cartridge Columns



Guide to HAI Speed 10 Cartridge Part Numbers

xF-0310-xxxx 30 x 10mm cartridge
 xF-0510-xxxx 50 x 10mm cartridge
 xF-1010-xxxx 100 x 10mm cartridge

See Page 23 for complete Part Number information

HAISpeed 10 - A high performance 10mm I.D. Cartridge System

High throughput requirements for combinatorial chemistry applications often call for 10mm I.D. columns. Higgins Analytical has developed a convenient cartridge system that offers an economical solution for demanding combinatorial and semi-preparative needs. Even though a HAI Speed 10 cartridge costs a fraction of conventional 10mm HPLC column of the same length, they have the same consistently high performance of other Higgins Analytical columns.

Each 5cm and 10cm cartridge column is tested and is shipped with a CofA.

CLIQUEUS 10mm I.D. Semi-Prep Cartridges



CLIQUEUS C18 10µm

10mm I.D. s.s. Guard Cartridges

30x10mm 2/pkg
 CF-0310-C181 \$275

10mm I.D. s.s. Semi-Prep Cartridges

50x10mm 1/pkg 100x10mm 1/pkg
 CF-0510-C181 \$215 CF-1010-C181 \$270

CLIQUEUS C18 5µm

10mm I.D. s.s. Semi-Prep Cartridges

50x10mm 1/pkg 100x10mm 1/pkg
 CF-0510-C185 \$315 CF-1010-C185 \$395

HAISIL 100 10mm I.D. Semi-Prep Cartridges



HAISIL 300 C18 10µm

10mm I.D. s.s. Guard Cartridges

30x10mm 2/pkg
 HF-0310-W181 \$275

10mm I.D. s.s. Semi-Prep Cartridges

50x10mm 1/pkg 100x10mm 1/pkg
 HF-0510-W181 \$215 HF-1010-W181 \$270

HAISIL 300 10mm I.D. Semi-Prep Cartridges



HAISIL 300 C18 5µm

10mm I.D. s.s. Semi-Prep Cartridges

50x10mm 1/pkg 100x10mm 1/pkg
 HF-0510-W185 \$315 HF-1010-W185 \$395

PROTO 200 10mm I.D. Semi-Prep Cartridges

200

PROTO 200 C4 10µm

10mm I.D. s.s. Guard Cartridges

30x10mm 2/pkg
 RF-0310-D041 \$275

10mm I.D. s.s. Semi-Prep Cartridges

50x10mm 1/pkg 100x10mm 1/pkg
 RF-0510-D041 \$215 RF-1010-D041 \$270

PROTO 200 C4 5µm

10mm I.D. s.s. Semi-Prep Cartridges

50x10mm 1/pkg 100x10mm 1/pkg
 RF-0510-D045 \$315 RF-1010-D045 \$395

PROTO 200 C18 10µm

10mm I.D. s.s. Guard Cartridges

30x10mm 2/pkg
 RF-0310-D181 \$275

10mm I.D. s.s. Semi-Prep Cartridges

50x10mm 1/pkg 100x10mm 1/pkg
 RF-0510-D181 \$215 RF-1010-D181 \$270

PROTO 200 C18 5µm

10mm I.D. s.s. Semi-Prep Cartridges

50x10mm 1/pkg 100x10mm 1/pkg
 RF-0510-D185 \$315 RF-1010-D185 \$395



PROTO 300 10mm I.D. Semi-Prep Cartridges



PROTO 300 C4 10µm

10mm I.D. s.s. Guard Cartridges

30x10mm	2/pkg
RF-0310-W041	\$275

10mm I.D. s.s. Semi-Prep Cartridges

50x10mm	1/pkg	100x10mm	1/pkg
RF-0510-W041	\$215	RF-1010-W041	\$270

PROTO 300 C4 5µm

10mm I.D. s.s. Semi-Prep Cartridges

50x10mm	1/pkg	100x10mm	1/pkg
RF-0510-W045	\$315	RF-1010-W045	\$395

PROTO 300 C18 10µm

10mm I.D. s.s. Guard Cartridges

30x10mm	2/pkg
RF-0310-W181	\$275

10mm I.D. s.s. Semi-Prep Cartridges

50x10mm	1/pkg	100x10mm	1/pkg
RF-0510-W181	\$215	RF-1010-W181	\$270

PROTO 300 C18 5µm

10mm I.D. s.s. Semi-Prep Cartridges

50x10mm	1/pkg	100x10mm	1/pkg
RF-0510-W185	\$315	RF-1010-W185	\$395

PHALANX 10mm I.D. Semi-Prep Cartridges



PHALANX C18 10µm

10mm I.D. s.s. Guard Cartridges

30x10mm	2/pkg
PF-0310-C181	\$275

10mm I.D. s.s. Semi-Prep Cartridges

50x10mm	1/pkg	100x10mm	1/pkg
PF-0510-C181	\$215	PF-1010-C181	\$270

PHALANX C18 5µm

10mm I.D. s.s. Semi-Prep Cartridges

50x10mm	1/pkg	100x10mm	1/pkg
PF-0510-C185	\$315	PF-1010-C185	\$395

TARGA 10mm I.D. Semi-Prep Cartridges



TARGA C18 10µm

10mm I.D. s.s. Guard Cartridges

30x10mm	2/pkg
TF-0310-C181	\$275

10mm I.D. s.s. Semi-Prep Cartridges

50x10mm	1/pkg	100x10mm	1/pkg
TF-0510-C181	\$215	TF-1010-C181	\$270

TARGA C18 5µm

10mm I.D. s.s. Semi-Prep Cartridges

50x10mm	1/pkg	100x10mm	1/pkg
TF-0510-C185	\$315	TF-1010-C185	\$395

See pages 72 - 73 for information about Cartridge Holders required for these Cartridges

NEW
10mm guard Cartridges

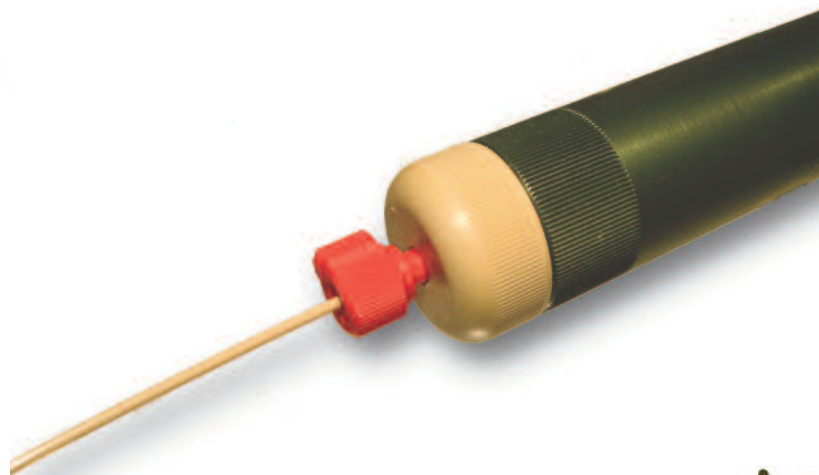

HAIPEEK & HAICART Guards

PEEK/TITANIUM and s.s. Guard Cartridges



Guide to HAIPEEK and HAICART Guard Cartridge Part Numbers

xK-0221-xxxx 20 x 2.1mm PEEK/titanium guard cartridge
 xF-0232-xxxx 20 x 3.2mm stainless steel guard cartridge

See Page 23 for complete Part Number information

Note: Old HAICART P/INs such as HI 18, TI 18, CIPH, etc. can still be used when ordering.

Analytical Guard Cartridges

The complete range of sorbents manufactured by Higgins Analytical is available in 2cm x 2.1 or 3.2mm I.D. guard cartridges. Not only does this provide a wide selection of products for protecting analytical and narrowbore HPLC columns, it also facilitates a wide variety of trace enrichment, column switching, and ballistic gradient applications.

These 2cm long cartridges require a reusable holder and are compatible with Higgins Analytical's HAIPEEK Guard Holders as well as PE/Brownlee's NewGuard Holder.

CLIQUEUS Guard Cartridges



CLIQUEUS C8 5µm

2.1mm I.D. Peek/Titanium
 20X2.1mm 5/pkg
 CK-0221-C085 \$180

3.2mm I.D. Stainless Steel
 20X3.2mm 5/pkg
 CF-0232-C085 \$175

CLIQUEUS C18 5µm

2.1mm I.D. Peek/Titanium
 20X2.1mm 5/pkg
 CK-0221-C185 \$180

3.2mm I.D. Stainless Steel
 20X3.2mm 5/pkg
 CF-0232-C185 \$175

CLIQUEUS Cyano 5µm

2.1mm I.D. Peek/Titanium
 20X2.1mm 5/pkg
 CK-0221-CNP5 \$180

3.2mm I.D. Stainless Steel
 20X3.2mm 5/pkg
 CF-0232-CNP5 \$185

CLIQUEUS Phenyl 5µm

2.1mm I.D. Peek/Titanium
 20X2.1mm 5/pkg
 CK-0221-PHN5 \$180

3.2mm I.D. Stainless Steel
 20X3.2mm 5/pkg
 CF-0232-PHN5 \$185

CLIQUEUS Silica 5µm

2.1mm I.D. Peek/Titanium
 20X2.1mm 5/pkg
 CK-0221-SIL5 \$180

3.2mm I.D. Stainless Steel
 20X3.2mm 5/pkg
 CF-0232-SIL5 \$175

HAISIL 100 Guard Cartridges



HAISIL 100 C8 5µm

2.1mm I.D. Peek/Titanium
 20X2.1mm 5/pkg
 HK-0221-M085 \$160

3.2mm I.D. Stainless Steel
 20X3.2mm 5/pkg
 HF-0232-M085 \$155

HAISIL 100 C18 5µm

2.1mm I.D. Peek/Titanium
 20X2.1mm 5/pkg
 HK-0221-M185 \$160

3.2mm I.D. Stainless Steel
 20X3.2mm 5/pkg
 HF-0232-M185 \$155



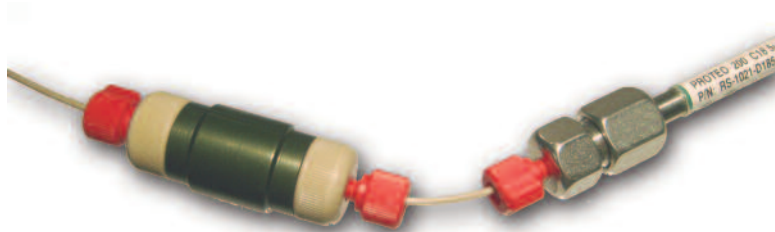

HAISIL 300 Guard Cartridges



HAISIL 300 C18 5µm

2.1mm I.D. Peek/Titanium

20X2.1mm 5/pkg
HK-0221-W185 \$190

3.2mm I.D. Stainless Steel

20X3.2mm 5/pkg
HF-0232-W185 \$190

HAISIL HL Guard Cartridges



HAISIL HL C18 5µm

2.1mm I.D. Peek/Titanium

20X2.1mm 5/pkg
LK-0221-C185 \$190

3.2mm I.D. Stainless Steel

20X3.2mm 5/pkg
LF-0232-C185 \$190

HEAVY Guard Cartridges



HEAVY C18 5µm

2.1mm I.D. Peek/Titanium

20X2.1mm 5/pkg
VK-0221-C185 \$190

3.2mm I.D. Stainless Steel

20X3.2mm 5/pkg
VF-0232-C185 \$190

PHALANX Guard Cartridges



PHALANX C18 5µm

2.1mm I.D. Peek/Titanium

20X2.1mm 5/pkg
PK-0221-C185 \$190

3.2mm I.D. Stainless Steel

20X3.2mm 5/pkg
PF-0232-C185 \$190

PROTO 200 Guard Cartridges

200

PROTO 200 C4 5µm

2.1mm I.D. Peek/Titanium

20X2.1mm 5/pkg
RK-0221-D045 \$190

3.2mm I.D. Stainless Steel

20X3.2mm 5/pkg
RF-0232-D045 \$190

PROTO 200 C18 5µm

2.1mm I.D. Peek/Titanium

20X2.1mm 5/pkg
RK-0221-D185 \$190

3.2mm I.D. Stainless Steel

20X3.2mm 5/pkg
RF-0232-D185 \$190

PROTO 300 Guard Cartridges



PROTO 300 C4 5µm

2.1mm I.D. Peek/Titanium

20X2.1mm 5/pkg
RK-0221-W045 \$190

3.2mm I.D. Stainless Steel

20X3.2mm 5/pkg
RF-0232-W045 \$190

PROTO 300 C18 5µm

2.1mm I.D. Peek/Titanium

20X2.1mm 5/pkg
RK-0221-W185 \$190

3.2mm I.D. Stainless Steel

20X3.2mm 5/pkg
RF-0232-W185 \$190

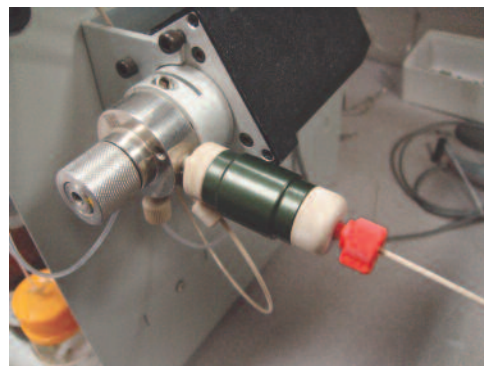

TARGA Guard Cartridges



TARGA C8 5µm

2.1mm I.D. Peek/Titanium
 20X2.1mm 5/pkg
 TK-0221-C085 \$180

3.2mm I.D. Stainless Steel
 20X3.2mm 5/pkg
 TF-0232-C085 \$175

TARGA C18 5µm

2.1mm I.D. Peek/Titanium
 20X2.1mm 5/pkg
 TK-0221-C185 \$180

3.2mm I.D. Stainless Steel
 20X3.2mm 5/pkg
 TF-0232-C185 \$175

POLYMERIC Reverse Phase Guard Cartridges

POLYMERIC PLRP-S 100Å 3µm

2.1mm I.D. Peek/Titanium
 20X2.1mm 5/pkg
 PLK-0221-RP13 \$225

3.2mm I.D. Stainless Steel
 20X3.2mm 5/pkg
 PLF-0232-RP13 \$225

POLYMERIC PLRP-S 300Å 3µm

2.1mm I.D. Peek/Titanium
 20X2.1mm 5/pkg
 PLK-0221-RP33 \$225

3.2mm I.D. Stainless Steel
 20X3.2mm 5/pkg
 PLF-0232-RP33 \$225

POLYMERIC PLRP-S 1000Å 5µm

2.1mm I.D. Peek/Titanium
 20X2.1mm 5/pkg
 PLK-0221-RP1K5 \$225

3.2mm I.D. Stainless Steel
 20X3.2mm 5/pkg
 PLF-0232-RP1K5 \$225

POLYMERIC PLRP-S 4000Å 5µm

2.1mm I.D. Peek/Titanium
 20X2.1mm 5/pkg
 PLK-0221-RP4K5 \$225

3.2mm I.D. Stainless Steel
 20X3.2mm 5/pkg
 PLF-0232-RP4K5 \$225

POLYMERIC Strong Anion Exchange Guard Cartridges

POLYMERIC SAX 1000Å 5µm

2.1mm I.D. Peek/Titanium
 20X2.1mm 5/pkg
 PLK-0221-AX1K5 \$225

3.2mm I.D. Stainless Steel
 20X3.2mm 5/pkg
 PLF-0232-AX1K5 \$225

POLYMERIC SAX 4000Å 5µm

2.1mm I.D. Peek/Titanium
 20X2.1mm 5/pkg
 PLK-0221-AX4K5 \$225

3.2mm I.D. Stainless Steel
 20X3.2mm 5/pkg
 PLF-0232-AX4K5 \$225

POLYMERIC Strong Cation Exchange Guard Cartridges

POLYMERIC SCX 1000Å 5µm

2.1mm I.D. Peek/Titanium
 20X2.1mm 5/pkg
 PLK-0221-SCX1K5 \$225

3.2mm I.D. Stainless Steel
 20X3.2mm 5/pkg
 PLF-0232-SCX1K5 \$225

POLYMERIC SCX 4000Å 5µm

2.1mm I.D. Peek/Titanium
 20X2.1mm 5/pkg
 PLK-0221-SCX4K5 \$225

3.2mm I.D. Stainless Steel
 20X3.2mm 5/pkg
 PLF-0232-SCX4K5 \$225

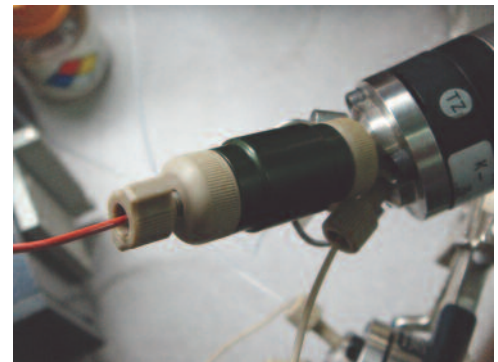

POLYMERIC Weak Anion Exchange Guard Cartridges

POLYMERIC WAX 1000Å 5µm

2.1mm I.D. Peek/Titanium

20X2.1mm 5/pkg
 PLK-0221-WAX1K5 \$225

3.2mm I.D. Stainless Steel

20X3.2mm 5/pkg
 PLF-0232-WAX1K5 \$225

POLYMERIC WAX 4000Å 5µm

2.1mm I.D. Peek/Titanium

20X2.1mm 5/pkg
 PLK-0221-WAX4K5 \$225

3.2mm I.D. Stainless Steel

20X3.2mm 5/pkg
 PLF-0232-WAX4K5 \$225

POLYMERIC Weak Guard Cartridges

POLYMERIC WCX 1000Å 5µm

2.1mm I.D. Peek/Titanium

20X2.1mm 5/pkg
 PLK-0221-WCX1K5 \$225

3.2mm I.D. Stainless Steel

20X3.2mm 5/pkg
 PLF-0232-WCX1K5 \$225

POLYMERIC WCX 4000Å 5µm

2.1mm I.D. Peek/Titanium

20X2.1mm 5/pkg
 PLK-0221-WCX4K5 \$225

3.2mm I.D. Stainless Steel

20X3.2mm 5/pkg
 PLF-0232-WCX4K5 \$225

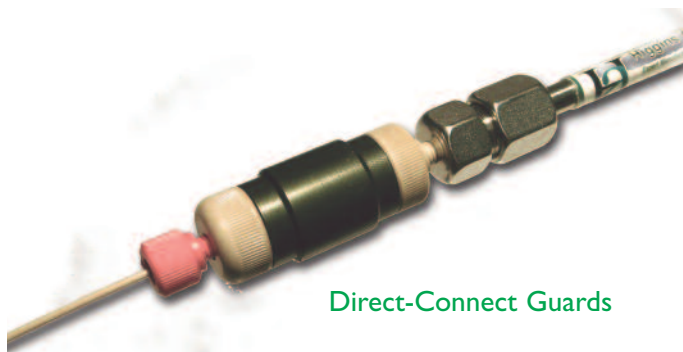

Direct-Connect Guards

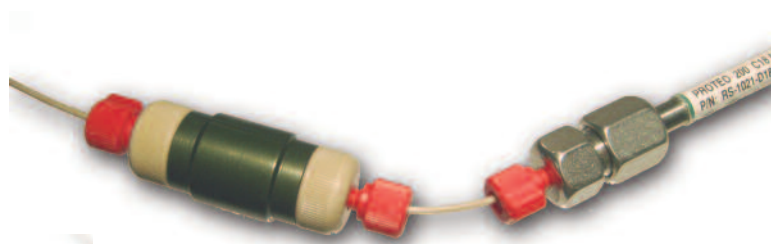

Analytical Guards

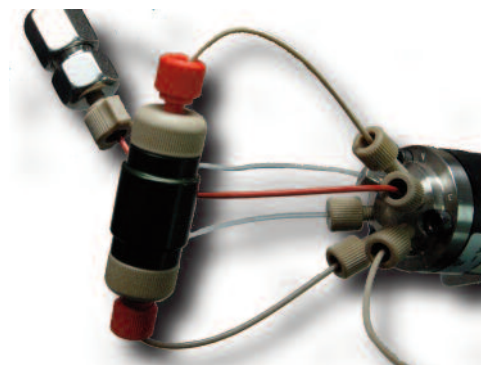

Loop-Column applications



HAISpeed20 CARTRIDGES

20mm I.D. Prep Guard Cartridge Columns



HAISpeed20 guard cartridges provide unique Protection for 20mm I.D. prep columns.

"Prep is a dirty business," and expensive columns can be quickly destroyed by crude samples if proper precautions are not taken. Higgins Analytical's HAISpeed20 Prep Guard System provides effective column protection without compromising performance. In addition to an efficiently packed bed which retains strongly absorbing junk that would change the selectivity of the prep column, these unique guard cartridges have 0.5µm frits that remove particulate contaminants as well.

Guide to HAISpeed 20 Cartridge Part Numbers

xF-0220-xxxx 25 x 20mm cartridge

See Page 23 for complete Part Number information

HAISpeed20 guard cartridges provide convenience and performance

HAISIL 100 C18 5µm
Dimensions 250 x 20mm
Catalog No. HS-2520-M185
Serial No. 937306

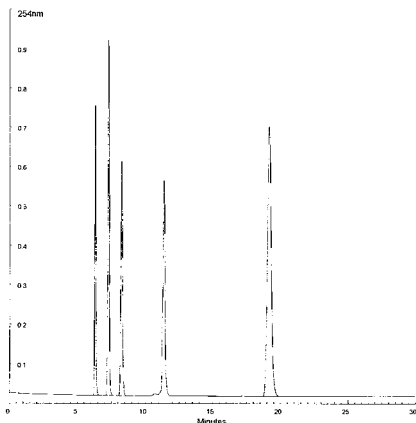

Catalog No.	HS-2520-M185		
Description:	HAISIL 100 C18 5µm		
Dimensions:	250 x 20mm		
Sorbent Lot#:	A18143	Monofunctional/Endcapped	
Particle Size:	5µm		
Pore Size:	100 Å		
Mobile Phase:	70% Acetonitrile in Water		
Flow Rate:	10mL/min		
Pressure:	33 bar	Temp:	29.5 °C
Peak: IR(min)		Plates(N)	Skewness
# 1	6.31	Dimethyl Phthalate	21,383 0.217
# 2	7.28	Nitrobenzene	21,020 0.164
# 3	8.25	Anisole	20,183 0.190
# 4	11.36	Diphenylamine	
# 5	19.16	Fluorene	18,694 0.161

File: 072 26/3

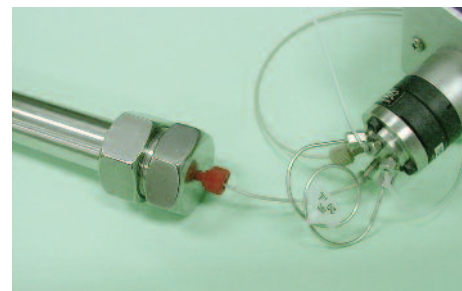

Typical 250x20mm HAISIL 100 C18 5µm Test Chromatogram.

HAISIL 300 C18 12µm
Dimensions 25 x 20mm
Catalog No. HF-0220-W182
Batch No. 260402

Coupled to

HAISIL 100 C18 5µm
Dimensions 250 x 20mm
Catalog No. HS-2520-M185

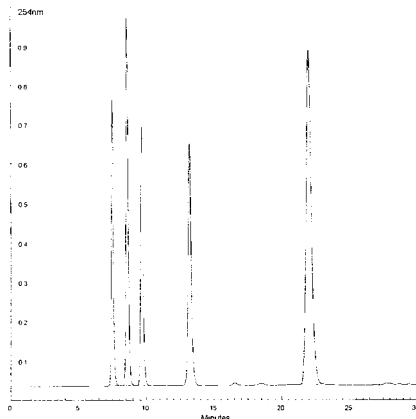

Catalog No.	HF-0220-W182		
Description:	HAISIL 300 C18 12µm		
Dimensions:	25 x 20mm		
Sorbent Lot#:	P25076	Monofunctional/Endcapped	
Particle Size:	12µm		
Pore Size:	300 Å		
Mobile Phase:	70% Acetonitrile in Water		
Flow Rate:	10mL/min		
Pressure:	bar	Temp:	28.5 °C
Peak: IR(min)		Plates(N)	Skewness
# 1	7.50	Dimethyl Phthalate	10,655 0.328
# 2	8.59	Nitrobenzene	10,725 0.298
# 3	9.67	Anisole	11,094 0.294
# 4	13.19	Diphenylamine	
# 5	22.01	Fluorene	12,886 0.238

File: 172 26/4



The same 250x20mm 5µm column shown in the top chromatogram retested with a HAISPEED 20 Guard Cartridge in line.



HAISIL 100 20mm I.D. Prep Guard Cartridges 

HAISIL 100 C18 10µm	20mm I.D.	s.s. Prep Guard Cartridges				
	25x20mm	2/pkg	35x20mm	1/pk	50x20mm	1/pk
	HF-0220-M181	\$295	HF-0320-M181	\$150	HF-0520-M181	\$200

CLIPEUS 20mm I.D. Prep Guard Cartridges 

CLIPEUS C18 10µm	20mm I.D.	s.s. Prep Guard Cartridges				
	25x20mm	2/pkg	35x20mm	1/pk	50x20mm	1/pk
	CF-0220-C181	\$295	CF-0320-C181	\$150	CF-0520-C181	\$200

HAISIL 300 20mm I.D. Prep Guard Cartridges 

HAISIL 300 C18 10µm	20mm I.D.	s.s. Prep Guard Cartridges				
	25x20mm	2/pkg	35x20mm	1/pk	50x20mm	1/pk
	HF-0220-W181	\$295	HF-0320-W181	\$150	HF-0520-W181	\$200

PROTO 200 20mm I.D. Prep Guard Cartridges 200 

PROTO 200 C4 10µm	20mm I.D.	s.s. Prep Guard Cartridges				
	25x20mm	2/pkg	35x20mm	1/pk	50x20mm	1/pk
	RF-0220-D041	\$295	RF-0320-D041	\$150	RF-0520-D041	\$200

PROTO 200 C18 10µm	20mm I.D.	s.s. Prep Guard Cartridges				
	25x20mm	2/pkg	35x20mm	1/pk	50x20mm	1/pk
	RF-0220-D181	\$295	RF-0320-D181	\$150	RF-0520-D181	\$200

PROTO 300 20mm I.D. Prep Guard Cartridges 

PROTO 300 C4 10µm	20mm I.D.	s.s. Prep Guard Cartridges				
	25x20mm	2/pkg	35x20mm	1/pk	50x20mm	1/pk
	RF-0220-W041	\$295	RF-0320-W041	\$150	RF-0520-W041	\$200

PROTO 300 C18 10µm	20mm I.D.	s.s. Prep Guard Cartridges				
	25x20mm	2/pkg	35x20mm	1/pk	50x20mm	1/pk
	RF-0220-W181	\$295	RF-0320-W181	\$150	RF-0520-W181	\$200

PHALANX 20mm I.D. Prep Guard Cartridges 

PHALANX C18 10µm	20mm I.D.	s.s. Prep Guard Cartridges				
	25x20mm	2/pkg	35x20mm	1/pk	50x20mm	1/pk
	PF-0220-C181	\$295	PF-0320-C181	\$150	PF-0520-C181	\$200

TARGA 20mm I.D. Prep Guard Cartridges 

TARGA C18 10µm	20mm I.D.	s.s. Prep Guard Cartridges				
	25x20mm	2/pkg	35x20mm	1/pk	50x20mm	1/pk
	TF-0220-C181	\$295	TF-0320-C181	\$150	TF-0520-C181	\$200

Both a Filter and a Guard

The 0.5µm pore size frits on HAI Speed20 cartridges provide unique built-in filtration for maximum column protection. These cartridges are shipped with end caps that prevent solvent loss and protect the cartridge and frits.



NEW
35x20mm and 50x20mm
Even greater capacity
for trapping and
purification



Cartridge Holders

Holders for 2.1, 3.2, 4.6, 10, and 20mm I.D. Cartridges

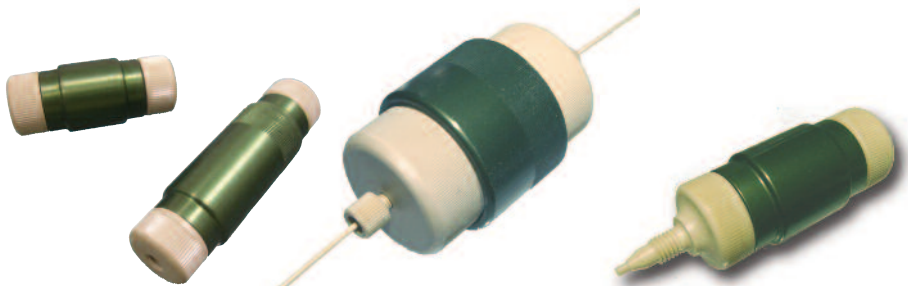

No Tools Required for Leak-Free Operation

Even though Higgins Analytical cartridge holders do not require any tools for assembly and disassembly, their leak-free operation assures that maximum performance will be achieved in your demanding, high-speed separations.

The Holder's light weight also makes it easy to handle and assures its compatibility in challenging plumbing situations.

Guide to Cartridge Holder Part Numbers

HK-GUARD-FF	Female/Female Holder for 2cm cartridge
HK-GUARD-FM	Female/Male Direct Connect Holder for 2cm cartridge
HK-HOLD-40	Holder for 4cm x 2.1, 3.2, 4.6mm cartridge
HK-HOLD-50	Holder for 5cm x 2.1, 3.2, 4.6mm cartridge
HK-HOLD-100	Holder for 10cm x 2.1, 3.2, 4.6mm cartridge
10-HOLD-30	Holder for 30x10mm cartridge
10-HOLD-50	Holder for 50x10mm cartridge
10-HOLD-100	Holder for 100x10mm cartridge
20-HOLD-25	Holder for 20 x 25mm cartridge

Higgins Analytical Cartridges and Holders enable a wide range of applications and techniques

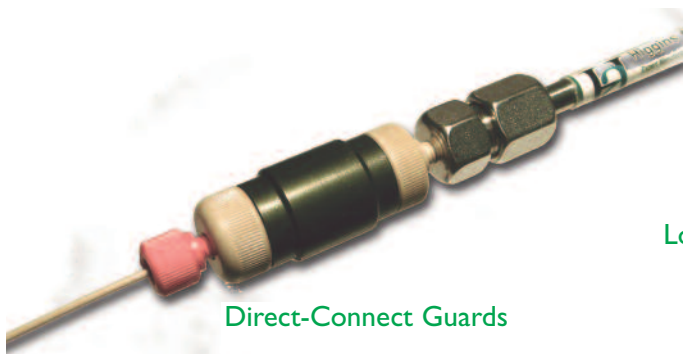

Direct-Connect Guards

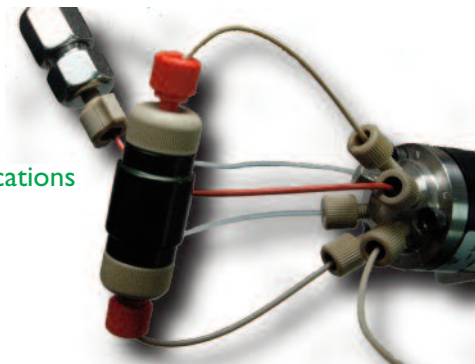

Loop-Column applications



2cm Guard Cartridge Holders

Direct Connect Holders

Female/Male Standard	Female/Male for Waters Column
HK-GUARD-FM \$160	WK-GUARD-FM \$160

Symmetrical Connection Holders

Female/Female Holder
HK-GUARD-FF \$175

Holdings for Analytical Cartridge Columns

Analytical Cartridge Holders

2cm Cartridges	4cm Cartridges	5cm Cartridges	10cm Cartridges
HK-HOLD-20 \$175	HK-HOLD-40 \$175	HK-HOLD-50 \$180	HK-HOLD-100 \$185

Note: HK-HOLD-20 is the same as HK-GUARD-FF

Holdings for 10mm I.D. Semi-Prep Guards and Cartridges

HAISPEED 10 Cartridge Holders

3cm Cartridges	5cm Cartridges	10cm Cartridges
10-HOLD-30 \$175	10-HOLD-50 \$180	10-HOLD-100 \$185

Holdings for 20mm I.D. Prep Guard Cartridges

HAISPEED 20 Guard Cartridge Holders

20x25mm Cartridges	20x35mm Cartridges	20x50mm Cartridges
20-HOLD-25 \$270	20-HOLD-35 \$270	20-HOLD-50 \$270

NEW
20x35 & 20x50mm Holders
See page 71 for the New Cartridges

Higgins Analytical manufacturers the widest range of guard cartridges in the world

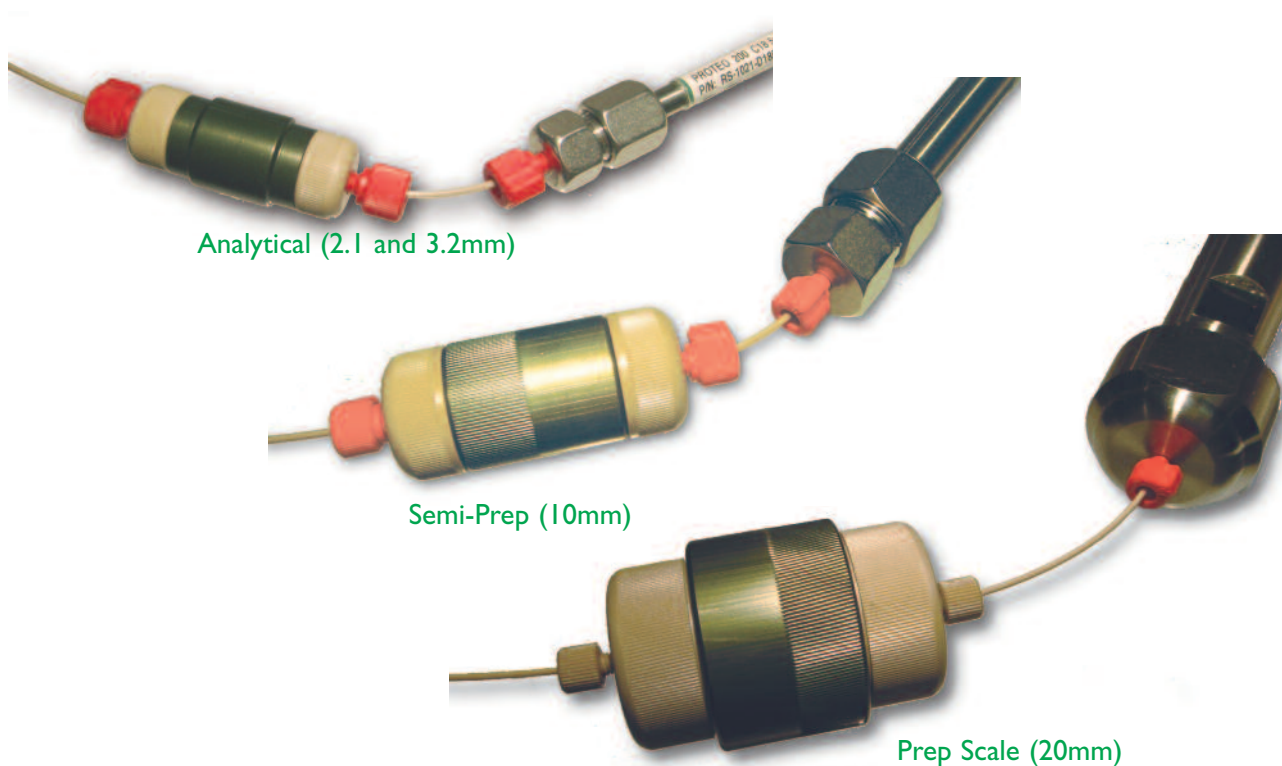

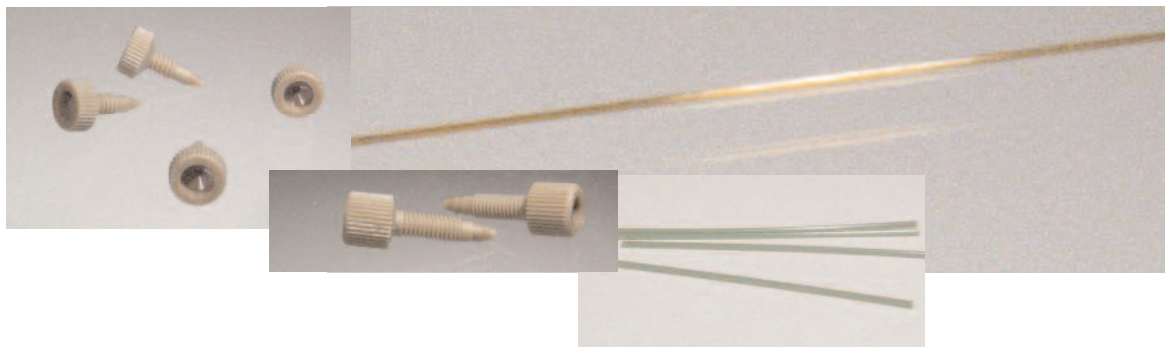

Micro Column Connector Kit

Kit facilitates plumbing a Piccolo, Sprite, or a Capillary to your instrument

Kit Contains:

- 6-32 PEEK Bushings (4 each)
- 10-32 PEEK Long Bushings (2 each)
- Green Sleeve 0.155 x 0.025" (4 each)
- Brown Sleeve 0.062 x 0.015" (2 each)
- Fused Silica Capillaries 10cm x 150 μ m (4 each)

MIC-KIT

\$100

Higgins Analytical develops and manufactures a wide range of stainless steel and PEEK (polyetheretherketone) High Performance Liquid Chromatography (HPLC) columns and cartridges. These unique offerings address many needs of chromatographers desiring fast analysis times, efficient system and column protection, and chemical inertness.

Special application areas include LC/MS, combinatorial chemistry, column switching techniques, in-line filtration, and guard column requirements. Products are supplied and supported worldwide by a network of responsive distributors.

We are a quality-oriented chromatography company dedicated to providing performance products, expert support, and rapid delivery to research and quality control laboratories worldwide.

Expert and Responsive Technical Support

As a Higgins Analytical Customer seeking technical support or product information, you will eliminate long waits and expensive phone calls, and you will never be transferred from one person to another only to end up in someone's phone mail! By simply faxing (1-650-988-8931) or e-mailing (hplc@higanalyt.com) your question to our Technical Support Group, you will receive a prompt written response. If we don't know the answer, we will tell you so – but, that doesn't happen very often. Additional up-to-date product and application information can be found by pointing your browser at our web site. www.higanalyt.com

Easy Ordering and Rapid Delivery

Our worldwide network of qualified distributors can provide expert support and prompt delivery from their local inventory. Our catalog-listed items are generally shipped from the factory within a day of receiving the order. In the event that we have not provided you with a near by distributor, we can ship an order to you directly from the factory by a variety of carriers.

In order to further simplify the process for you and your purchasing department,



Higgins Analytical and many of its distributors accept credit card orders. Payment terms for all other orders are net 30 days from date of invoice.

Product Availability

Higgins Analytical products are available worldwide through a network of responsive distributors. These organizations can provide qualified technical support and prompt product delivery. The names can be found by sending us a fax (650-988-8931) or by checking our web site which, in addition to names, addresses and phone numbers, contains many hyperlinked e-mail and URL addresses.



HIGGINS ANALYTICAL PRODUCTS MAY BE PURCHASED AND ARE SOLD ONLY ON THE FOLLOWING WARRANTY TERMS AND CONDITIONS. ADDITIONAL OR DIFFERENT TERMS, WHETHER IN AN ORDER, ACKNOWLEDGMENT, INVOICE OR OTHER DOCUMENT, SHALL NOT BECOME PART OF OR VARY THE FOLLOWING TERMS UNLESS AGREED TO IN WRITING BY HIGGINS ANALYTICAL.

LIMITED WARRANTY

Higgins Analytical products are manufactured and quality controlled to the highest industry standards, and Higgins Analytical warrants that the products, when properly applied in accordance with Higgins Analytical's standards therefor, will perform for a period of thirty (30) days after delivery substantially as described in Higgins Analytical's then current specifications for the product. If a customer believes a product does not comply with such warranty, the customer shall, within the warranty period, report the purported defect to Higgins Analytical and cooperate fully with Higgins Analytical in determining the conditions and cause of any purported defect and, thereby, obtain a returned goods authorization from Higgins Analytical or the place of purchase. If Higgins Analytical determines the alleged defect occurred as a result of misuse, neglect, improper installation, repair, alteration, application or accident, rapid depressurization, removal of column end fittings, unusual physical or electrical stress or improper handling procedure, the warranty shall be void and ineffective.

EXPRESS LIMITATIONS

HIGGINS ANALYTICAL PRODUCTS ARE MANUFACTURED FOR USE IN RESEARCH IN CHEMICAL MANUFACTURING LABORATORIES ONLY AND ARE NOT INTENDED FOR USE IN CLINICAL OR DIAGNOSTIC APPLICATIONS. THE HAI-SPEED 10 AND HAI-SPEED 20 CARTRIDGE HOLDERS ARE RATED FOR USE UP TO 3,000 PSI (200BAR) WITH FLUIDS THAT ARE LIQUID AT STP (STANDARD TEMPERATURE AND PRESSURE) ONLY. SERIOUS BODILY INJURY OR DEATH MAY RESULT IF A HAI-SPEED HOLDER BROKE WHILE WORKING WITH SUPERCRITICAL FLUIDS.

DISCLAIMER

EXCEPT AS EXPRESSLY PROVIDED, ALL WARRANTIES, CONDITIONS, REPRESENTATIONS, INDEMNITIES AND GUARANTEES, WHETHER EXPRESS OR IMPLIED, ARISING BY LAW, CUSTOM, PRIOR ORAL OR WRITTEN STATEMENTS BY HIGGINS ANALYTICAL OR OTHERWISE (INCLUDING, BUT NOT LIMITED TO, ANY WARRANTY FOR MERCHANTABILITY OR FITNESS FOR A PARTICULAR PURPOSE) ARE OVERRIDDEN, EXCLUDED AND DISCLAIMED.

EXCLUSIVE REMEDY

In the event a customer establishes a breach of the above warranty, customer's exclusive remedy against Higgins Analytical, and Higgins Analytical's sole liability, is, at its option, the replacement of the defective product or the refund of the purchase price therefor.

NO CONSEQUENTIAL DAMAGES

HIGGINS ANALYTICAL SHALL NOT BE RESPONSIBLE FOR ANY CONSEQUENTIAL, INDIRECT, SPECIAL, PUNITIVE OR INCIDENTAL DAMAGES, WHETHER FORESEEABLE OR UNFORESEEABLE, INCLUDING, BUT NOT LIMITED TO, CLAIMS FOR LOSS OF GOODWILL, PROFITS, USE OF MONEY OR USE OF PRODUCTS, STOPPAGE OF OTHER WORK OR IMPAIRMENT OF OTHER ASSETS, ARISING OUT OF BREACH OF EXPRESS OR IMPLIED WARRANTY, BREACH OF CONTRACT, MISREPRESENTATION, NEGLIGENCE, STRICT LIABILITY IN TORT OR OTHERWISE, EXCEPT ONLY IN THE CASE OF PERSONAL INJURY WHERE AND TO THE EXTENT THAT APPLICABLE LAW REQUIRES SUCH LIABILITY.

PATENTS AND TRADEMARKS

Kromasil is a trademark of Eka Nobel. NewGuard and MPLC are trademarks of Perkin-Elmer. PICOTAG is a trademark of Waters. CAPELLINI, CLIPEUS, HAI-SIL, HAICART, HAIFILTER, HAIPEEK, HAI-SPEED, HEAVY, TARGA[®], PHALANX, PROTO, HAIGUARD, PICCOLO, SPRITE, and Carillary are trademarks of Higgins Analytical, Inc.

Higgins Analytical develops and manufactures a wide range of stainless steel and PEEK (polyetheretherketone) High Performance Liquid Chromatography (HPLC) columns and cartridges. These unique offerings address many needs of chromatographers desiring fast analysis times, efficient system and column protection, and chemical inertness.

Special application areas include LC/MS, combinatorial chemistry, column switching techniques, in-line filtration, and guard column requirements. Products are supplied and supported worldwide by a network of responsive distributors.

We are a quality-oriented chromatography company dedicated to providing performance products, expert support, and rapid delivery to research and quality control laboratories worldwide.



Higgins Analytical

*Expert Manufacturers of
HPLC Consumables*

Higgins Analytical, Inc.
1235 Pear Avenue, Suite 105
Mountain View, California, 94043 USA
Phone: 650-988-8930 or 800-988-6889
Fax: 650-988-8931
hplc@higanalyt.com
www.higanalyt.com